



**ECE** —  
The Name You Can Trust!

## SURFACE MOUNT PTC SB (2016) MODEL

C  US E175689

### ■ FEATURES

- Mini surface mount, solid state
- Faster time to trip than standard SMD devices
- Lower resistance than standard SMD devices
- Operation current: 300mA~2.0A
- Maximum voltage: 6V~60Vdc
- Temperature range: -40°C to 85°C
- Tape and reel available on most models

### ■ APPLICATIONS

- ◆ Almost anywhere there High-density boards is a low voltage power supply and a load to be protected including:
  - Computers & peripherals
  - General electronics
  - Automotive applications

### ■ PART NUMBERING SYSTEM

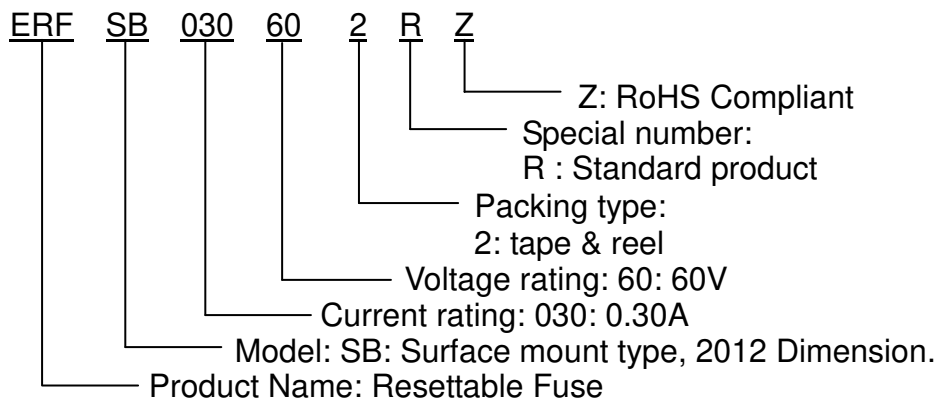

### ■ Marking system

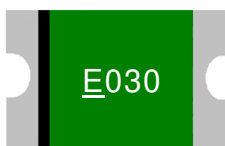

Example

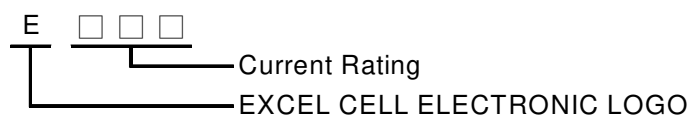



**ECE** —  
The Name You Can Trust!

## ■ Electrical characteristics(23°C)

Part Number	Hold Current	Trip Current	Rated Voltage	Maximum Current	Typical Power	Max. Time to trip		Resistance Tolerance	
						R <sub>MIN</sub>	R <sub>1MAX</sub>		
	I <sub>H</sub> , A	I <sub>T</sub> , A	V <sub>MAX</sub> , V <sub>dc</sub>	I <sub>MAX</sub> , A	P <sub>d</sub> , W	Amp	Sec	Ω	Ω
SB030-60	0.30	0.60	60	100	1.4	1.5	3.0	0.04	2.30
SB050-60	0.50	1.10	60	100	1.4	2.5	5.0	0.20	1.00
SB075-60	0.75	1.50	60	100	1.4	8.0	0.5	0.13	0.90
SB110-15	1.10	2.20	15	100	1.4	8.0	0.5	0.07	0.40
SB110-33	1.10	2.20	33	100	1.4	8.0	0.5	0.07	0.40
SB150-15	1.50	3.00	15	100	1.4	8.0	0.8	0.05	0.18
SB200-06	2.00	4.20	6	100	1.4	8.0	3.0	0.03	0.10

I<sub>H</sub>=Hold current-maximum current at which the device will not trip at 23°C still air.

I<sub>T</sub>=Trip current-minimum current at which the device will always trip at 23°C still air.

V<sub>MAX</sub>=Maximum voltage device can withstand without damage at rated current.

I<sub>MAX</sub>= Maximum fault current device can withstand without damage at rated voltage (V max).

P<sub>d</sub>=Typical power dissipated from device when in the tripped state in 23°C still air environment.

R<sub>MIN</sub>=Minimum device resistance at 23°C.

R<sub>1MAX</sub>=Maximum device resistance at 23°C 1 hour after tripping .

## ■ Typical time-to-trip-at 23°C

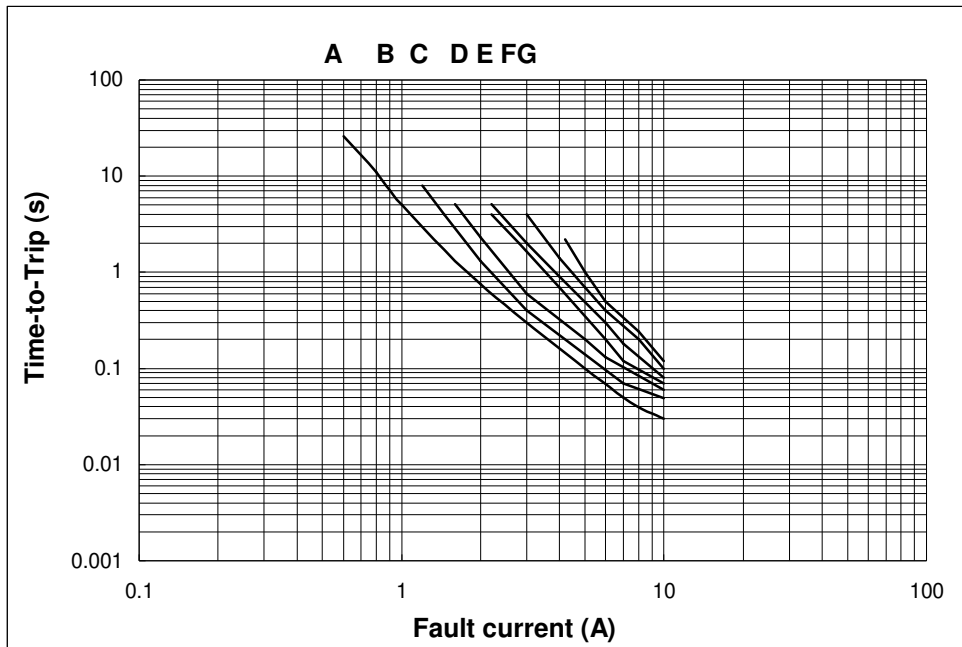

A =SB030-60  
B =SB050-60  
C =SB075-60  
D =SB110-15  
E =SB110-33  
F =SB150-15  
G =SB120-06

### Thermal Derating Curve

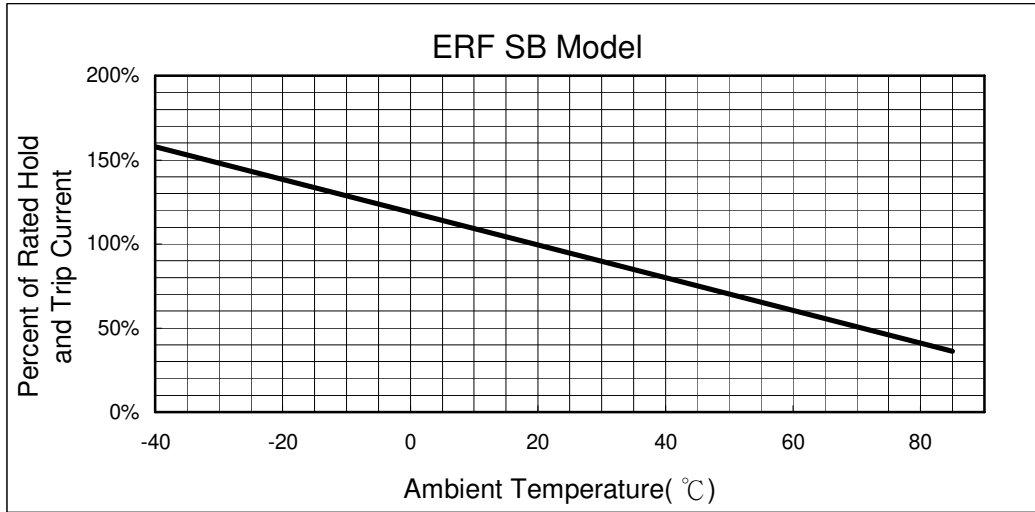

### Standard Package for Reference

P/N	Reel/Tape	P/N	Reel/Tape	P/N	Reel/Tape	P/N	Reel/Tape
SB030-60	2.0K	SB110-15	2.0K	SB200-06	2.0K		
SB050-60	1.0K	SB110-33	2.0K				
SB075-60	1.0K	SB150-15	2.0K				

### SB Product Dimensions (UNIT: mm)

PART NUMBER	A		B		C		D		E	
	Min	Max	Min	Max	Min	Max	Min	Max	Min	Max
SB030-60	4.72	5.44	3.70	4.33	0.40	1.15	0.30	1.50	0.25	0.65
SB050-60	4.72	5.44	3.70	4.33	0.40	1.70	0.30	1.50	0.25	0.65
SB075-60	4.72	5.44	3.70	4.33	0.40	1.70	0.30	1.50	0.25	0.65
SB110-15	4.72	5.44	3.70	4.33	0.30	0.70	0.30	1.50	0.25	0.65
SB110-33	4.72	5.44	3.70	4.33	0.30	0.70	0.30	1.50	0.25	0.65
SB150-15	4.72	5.44	3.70	4.33	0.25	0.65	0.30	1.50	0.25	0.65
SB200-06	4.72	5.44	3.70	4.33	0.25	0.65	0.30	1.50	0.25	0.65

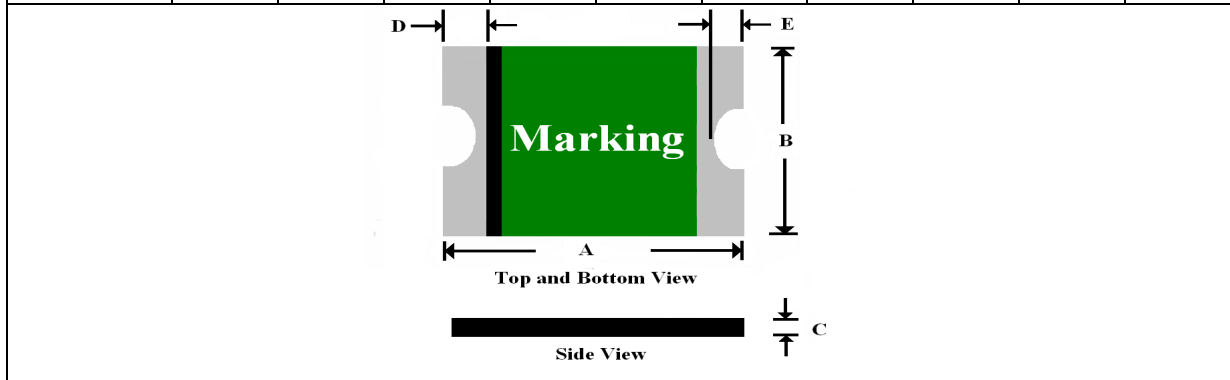

## ■ Pad Layouts and Soldering Reflow Recommendations

The dimension in the table below provide the recommended pad layout for each surface mount device

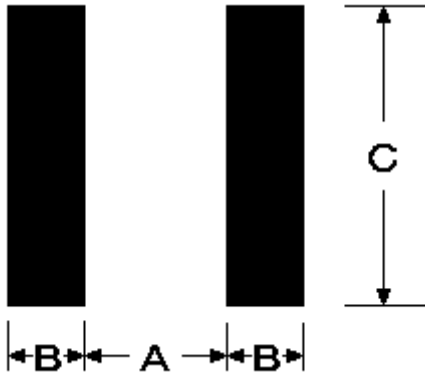

Pad dimensions(millimeters)			
Device	A Nominal	B Nominal	C Nominal
SL MODEL	5.10	2.30	5.60
SB MODEL	3.60	1.80	4.60
SD MODEL	3.45	1.78	3.50
SM MODEL	2.00	1.00	2.80
SN MODEL	2.00	1.00	1.90
SR MODEL	1.20	1.00	1.50
SS MODEL	0.80	0.60	0.80

## ■ SOLDERING REFLOW (LEAD FREE)

- 1.Suggested reflow methods: IR, vapor phase oven, hot air oven.
- 2.Recommended maximum paste thickness is 0.25mm.
- 3.Devices are not designed to wave soldered to the bottom side of the board.

## ■ CAUTION

If reflow temperatures exceed the recommended standard, devices may not be able to meet the performance requirements.

