



MACHINE PIN SOCKET

EMS SERIES

■ FEATURES

- Funnel shaped four-fingered and six-fingered contacts provide easy IC insertion and withdrawal, high reliability
- Gold plated contact to ensure low contact resistance and Tin plated terminal to prevent contamination during soldering
- All plastic are UL 94V-0 grade fire retardant
- Fit standard pitch with 2.54mm x 2.54mm (0.1" x 0.1") pin spacing

■ SPECIFICATIONS

1.MATERIAL

- Sleeve: Brass Gold or Tin over Nickel plated
- Clip: Beryllium Copper Gold over Nickel plated

2.ELECTRICAL

- Contact Rating: 1 Amp ,VDC Max.
- Contact Resistance: 100 mΩ Max.
- Insulation Resistance: 1000 MΩ Min. at 100 VDC
- Dielectric Strength: 1000 VAC Min. for 60 seconds
- Capacitance between adjacent pin 0.9pF Max.

3.MECHANICAL AND ENVIRONMENTAL

- Temperature Rating: Operating -40°C to +105°C
- Average insertion force with steel pin of Ø0.43mm/0.017" <250g
- Average withdrawal force with steel pin of Ø0.43mm/0.017" >25g
- Life cycle with insertion and withdrawal: 100 operations Min.
- Humidity: 90~95% RH, 40°C for 96 Hrs
- Vibration:10Hz-55Hz-10Hz for 6 Hrs
- Solderability:After flux 245±5°C for 5±1 seconds,90% Coverage
- Resistance to soldering heat: Solder bath: 260±5°C for 5±1 seconds

■ KINDS OF BASE

PGA TYPE

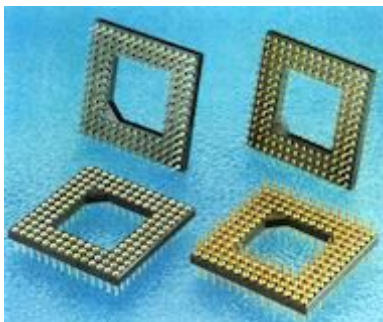

DIP TYPE



SIP TYPE





CONSTRUCTION OF PIN

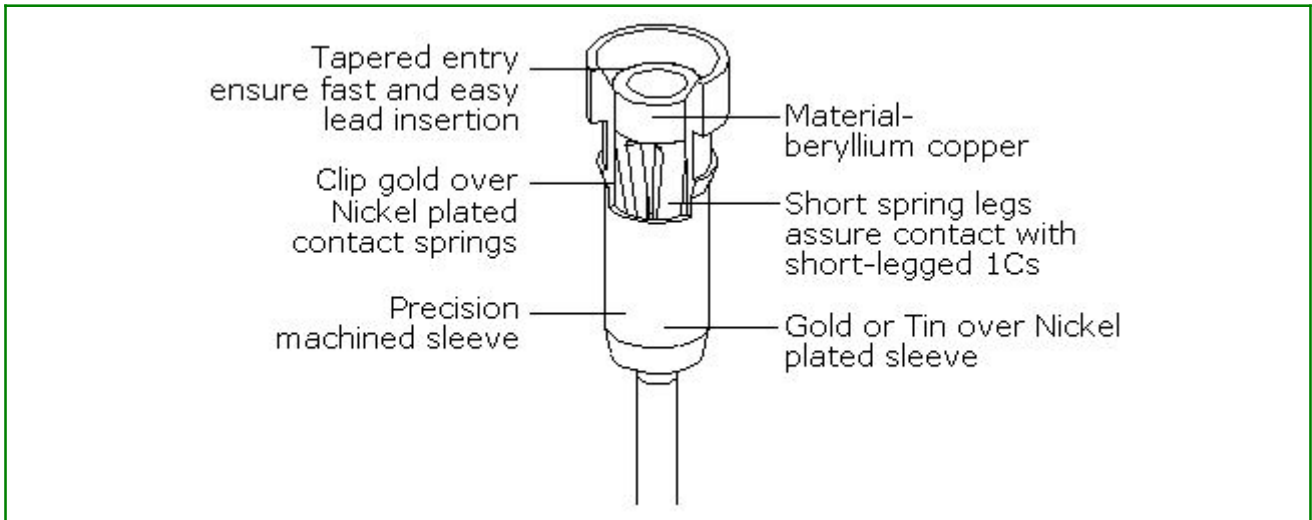

KINDS OF PIN: UNIT: mm(inch)

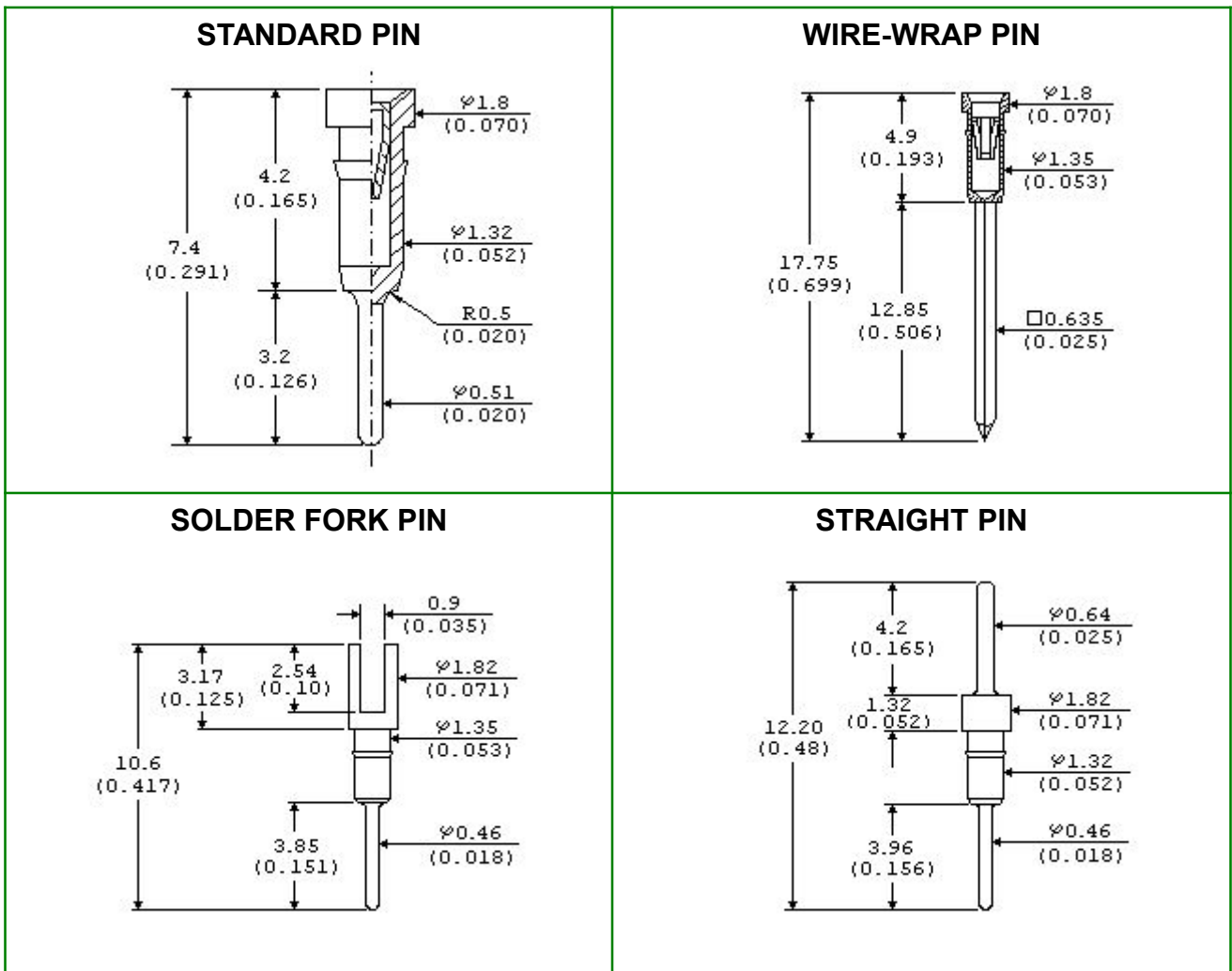



PGA TYPE

■ DIMENSIONS AND CIRCUITRY: UNIT: mm(inch)

● STANDARD PIN

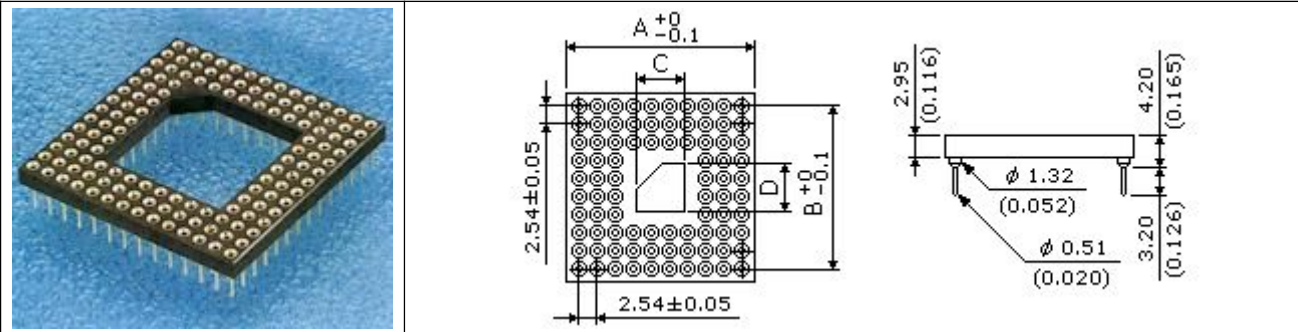

● STRAIGHT PIN

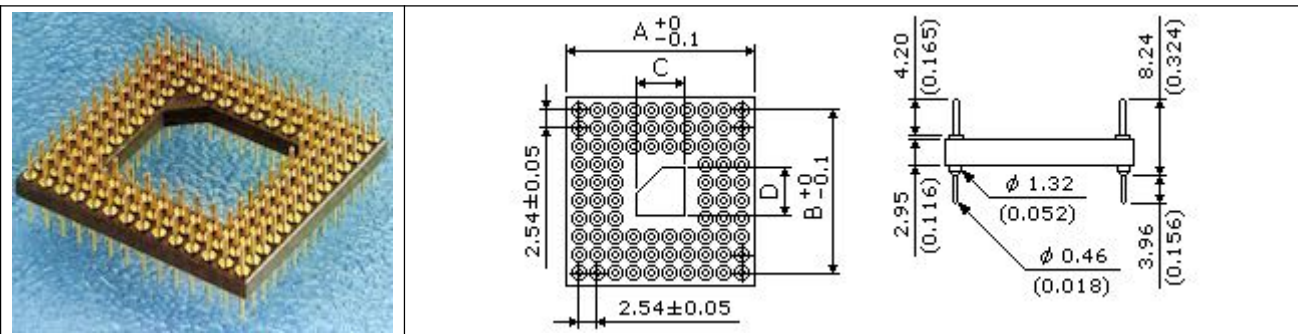

■ PART NUMBERING SYSTEM

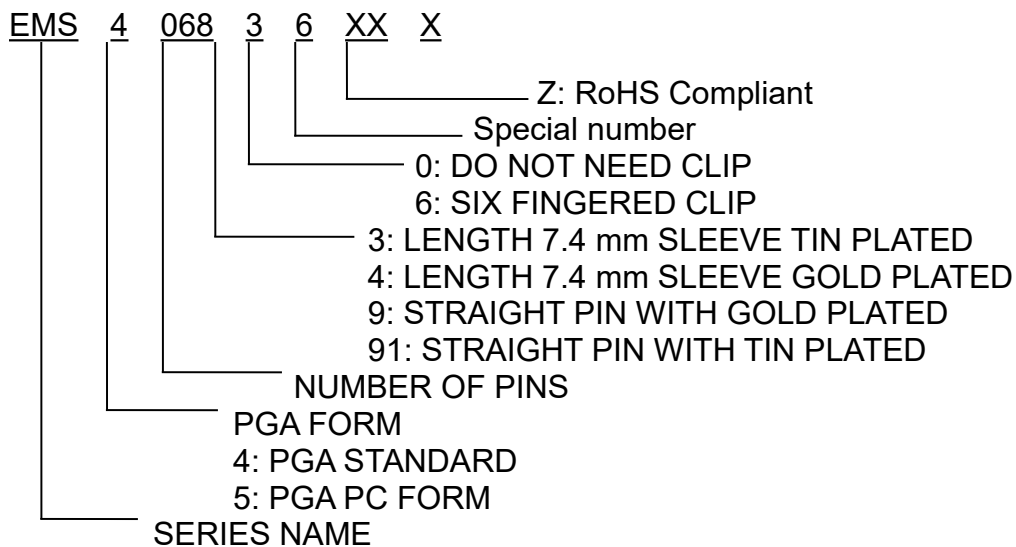



PART NO.	PIN NO.	A	B	C	D
EMS4044**	8×8×2/44 PIN	20.20	17.78	8.50	8.50
EMS4064**	10×10×2/64 PIN	25.20	22.86	12.70	12.70
EMS4065**	10×10×3/65 PIN	25.20	22.86	12.70	12.70
EMS4068**	11×11×2/68 PIN	28.50	28.50	17.50	17.50
EMS4072**	11×11×2/72 PIN	27.78	25.40	14.75	14.75
EMS4084**	13×13×2/84 PIN	33.60	30.48	17.80	17.80
EMS4096**	11×11×3/96 PIN	27.84	25.4	9.70	9.70
EMS4101**	13×13×3/101 PIN	32.92	30.48	17.20	17.20
EMS4121**	13×13×3/121 PIN	33.42	30.48	17.40	17.40
EMS4132**	14×14×3/132 PIN	35.96	33.02	19.90	19.90
EMS4133**	14×14×3/133 PIN	35.96	33.02	19.90	19.90
EMS4144**	15×15×3/144 PIN	38.50	35.56	20.30	20.30
EMS4145**	15×15×3/145 PIN	38.50	35.56	20.30	20.30
EMS4149**	15×15×4/149 PIN	39.15	35.56	17.70	17.70
EMS4168**	17×17×3/168 PIN	43.58	40.64	24.40	24.40
EMS4169**	17×17×3/169 PIN	43.58	40.64	24.40	24.40
EMS4176**	15×15×4/176 PIN	38.50	35.56	16.50	16.50
EMS4177**	15×15×5/177 PIN	38.50	35.56	16.50	16.50



■ STANDARD CONFIGURATIONS

● PGA PC FOORM

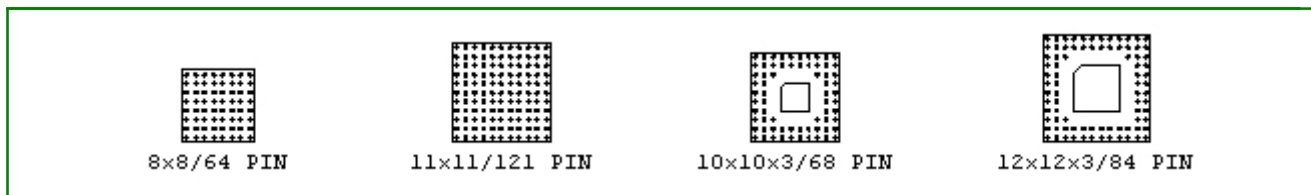
● SPECIAL FORM NO. ONE

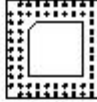
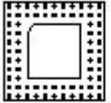
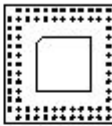
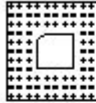
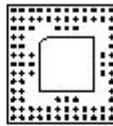
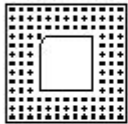
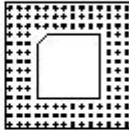
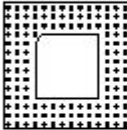
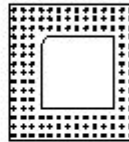
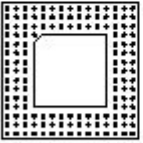
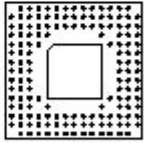
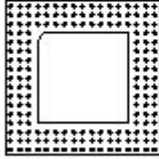
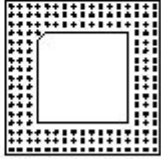
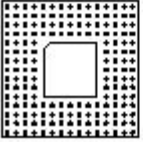
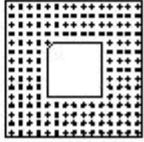
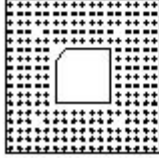
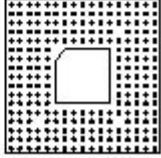

● PGA FOORM

 8x8x2/44 PIN	 10x10x2/64 PIN	 10x10x3/65 PIN	 11x11x2/68 PIN
 11x11x2/72 PIN	 13x13x2/84 PIN	 11x11x3/96 PIN	 13x13x3/101 PIN
 13x13x3/121 PIN	 14x14x3/132 PIN	 14x14x3/133 PIN	 15x15x3/144 PIN
 15x15x3/145 PIN	 15x15x4/149 PIN	 17x17x3/168 PIN	 17x17x3/169PIN
 15x15x4/176 PIN	 15x15x5/177 PIN	 17x17x5/236 PIN	 17x17x5/237 PIN

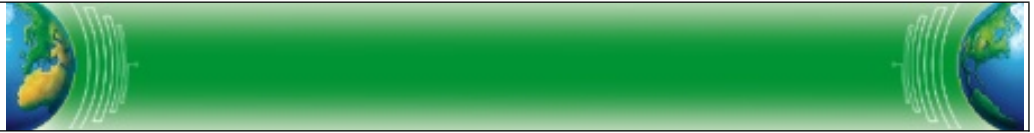

DIP TYPE

■ DIMENSIONS AND CIRCUITRY: UNIT: mm(inch)

● STANDARD PIN

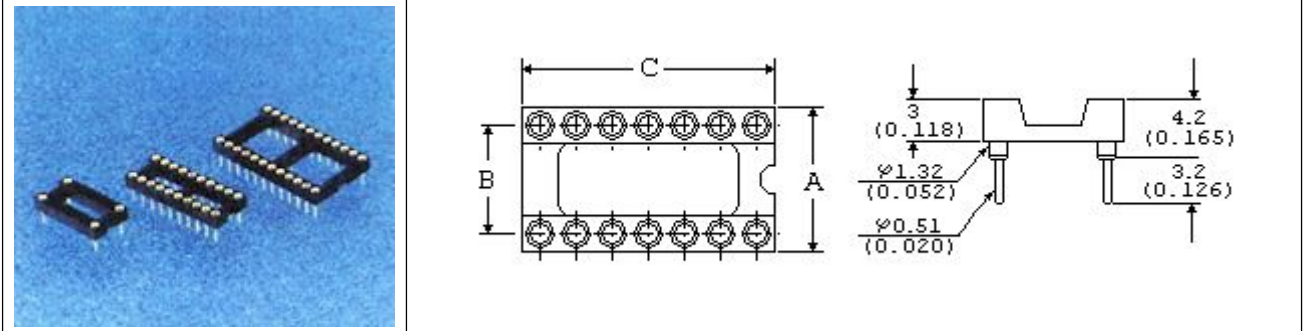

● WIRE-WRAP PIN

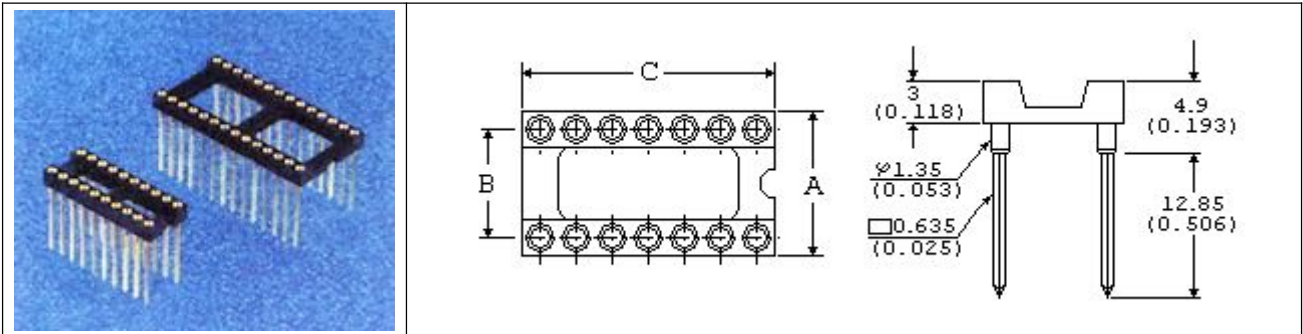

● SOLDER FORK PIN

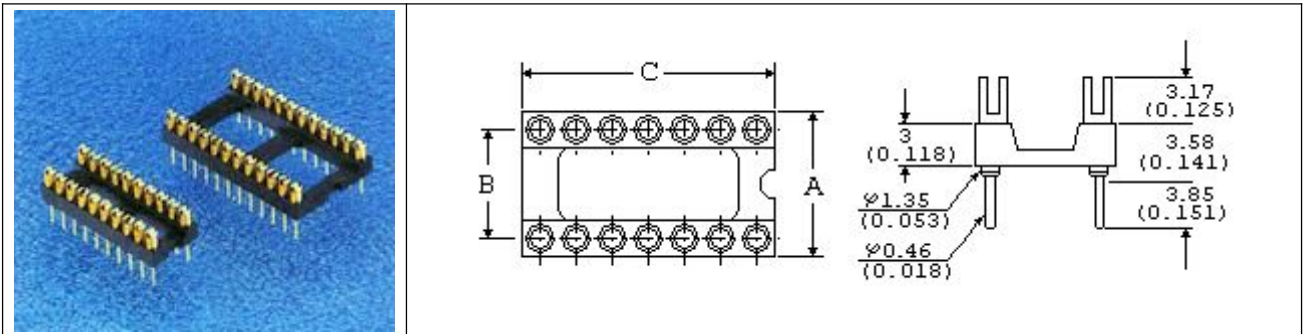

● STRAIGHT PIN

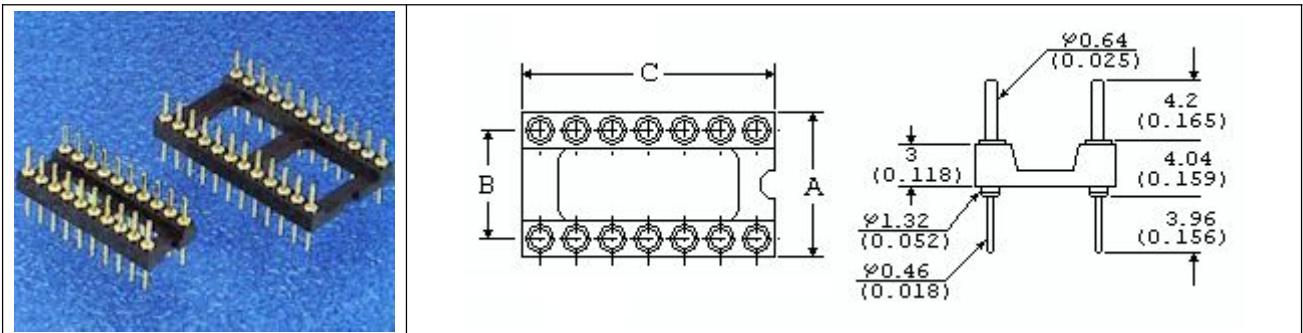



■ PART NUMBERING SYSTEM

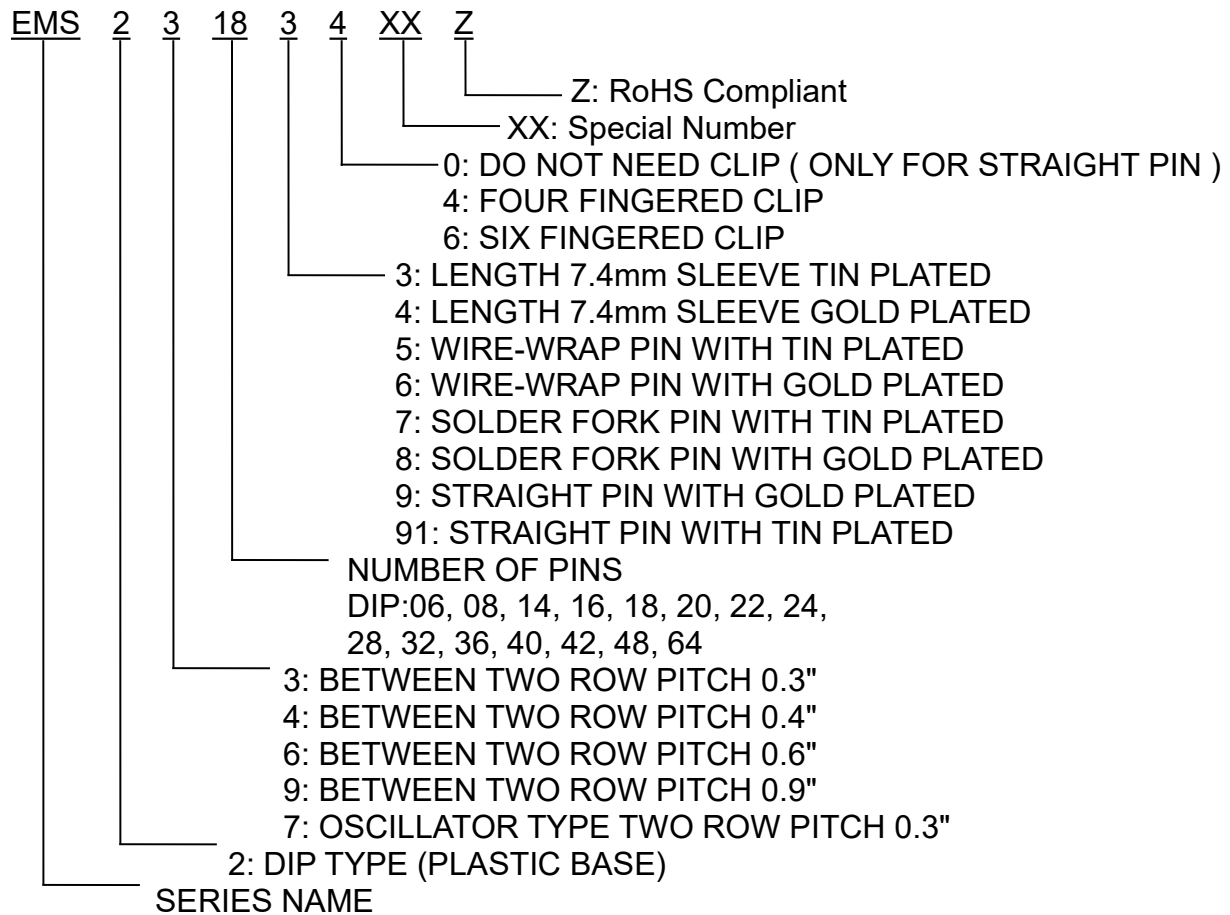

PART NO.	PIN NO.	A	B	C	PART NO.	PIN NO.	A	B	C
EMS2306**	6	10.1	7.62	7.6	EMS2324**	24	10.1	7.62	30.4
EMS2308**	8	10.1	7.62	10.1	EMS2624**	24	17.7	15.24	30.4
EMS2310**	10	10.1	7.62	12.7	EMS2628**	28	17.7	15.24	35.5
EMS2314**	14	10.1	7.62	17.7	EMS2632**	32	17.7	15.24	40.6
EMS2316**	16	10.1	7.62	20.3	EMS2636**	36	17.7	15.24	45.7
EMS2318**	18	10.1	7.62	22.8	EMS2640**	40	17.7	15.24	50.8
EMS2320**	20	10.1	7.62	25.4	EMS2648**	48	17.7	15.24	60.9
EMS2422**	22	12.7	10.16	27.9	EMS2964**	64	25.4	22.86	81.2



SIP TYPE

■ DIMENSIONS AND CIRCUITRY: UNIT: mm(inch)

● STANDARD PIN

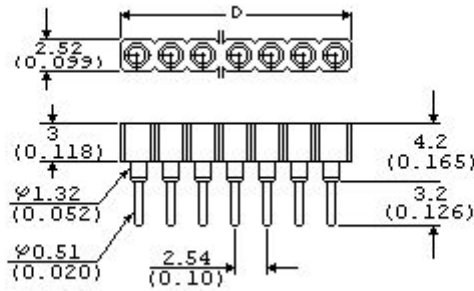
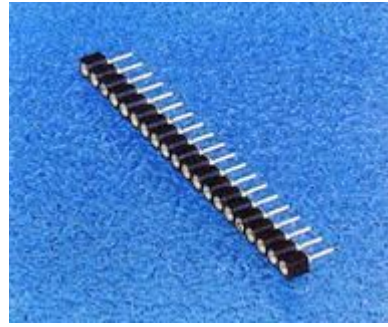

● WIRE-WRAP PIN

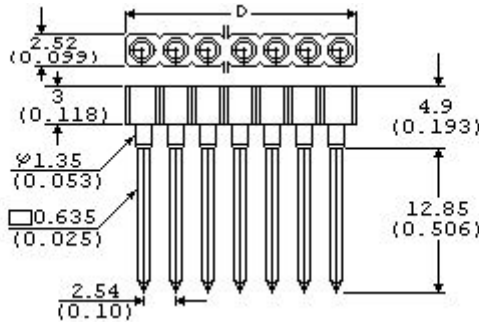
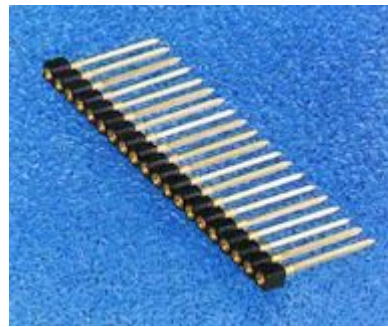

● SOLDER FORK PIN

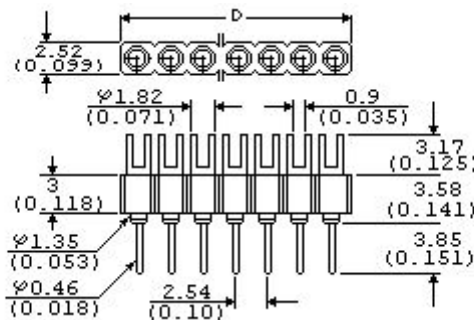
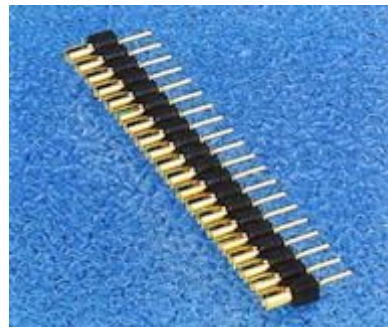

● STRAIGHT PIN

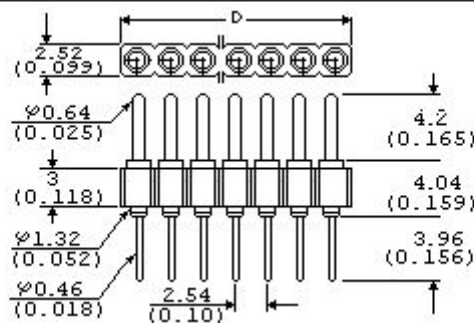

■ PART NUMBERING SYSTEM

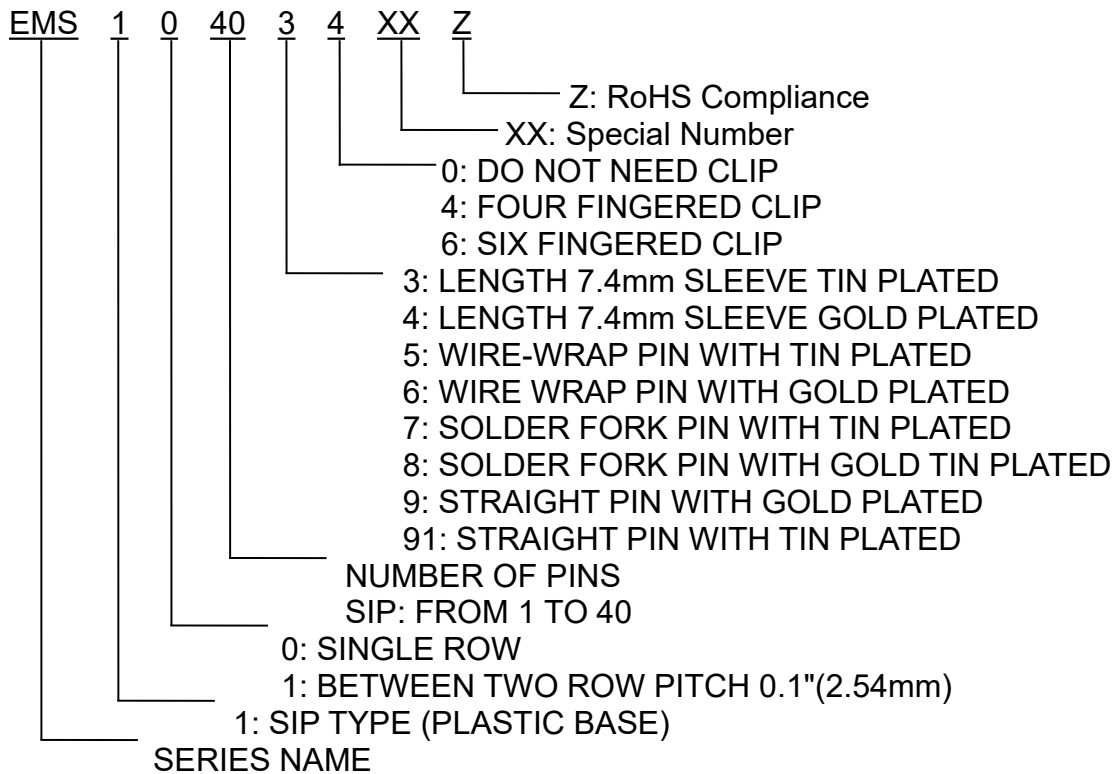

PART NO.	PIN NO.	D
EMS1006**	6	19.3
EMS1008**	8	20.3
EMS1010**	10	25.4
EMS1014**	14	35.5
EMS1016**	16	40.6
EMS1018**	18	45.7
EMS1020**	20	50.8
EMS1022**	22	55.9
EMS1024**	24	61.0
EMS1028**	28	71.1
EMS1030**	30	76.2
EMS1032**	32	81.3
EMS1036**	36	91.4
EMS1040**	40	101.6