

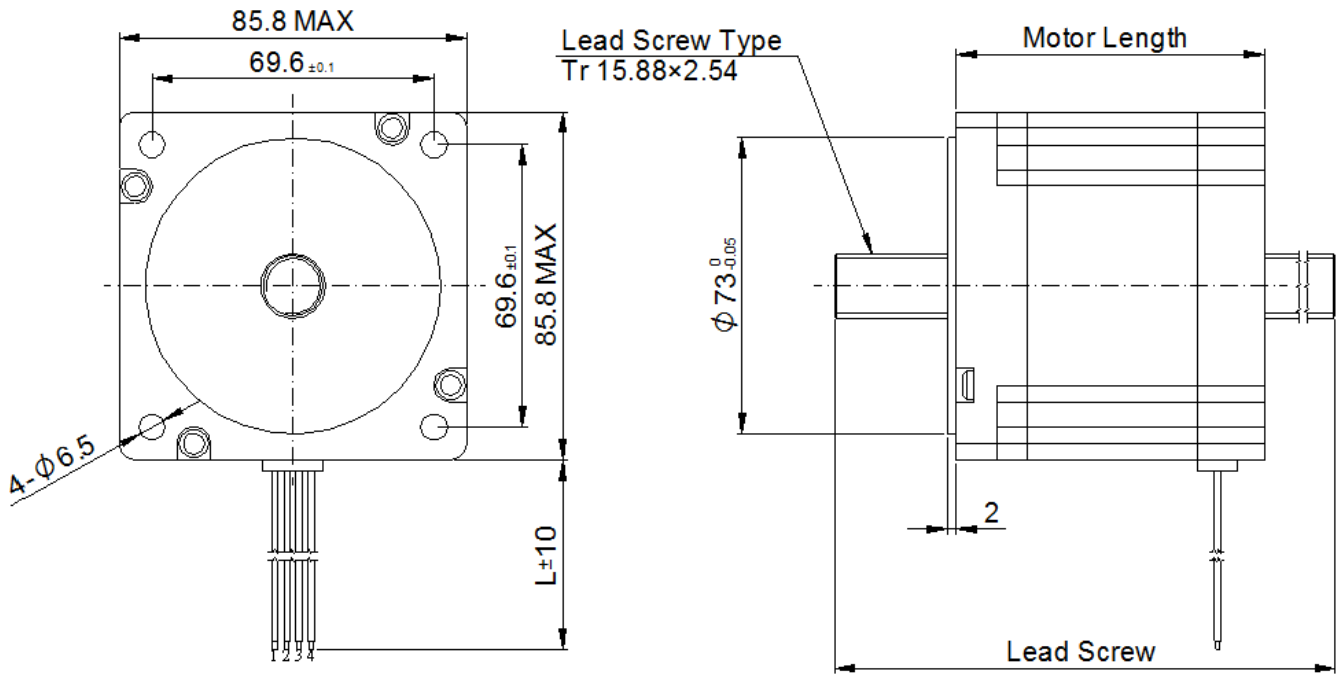

NEOCENE 2H86A(Linear) | SPECIFICATION



Model	2H86A(Bipolar)							
	Linear Travel	Step Angle	Force (375pps)	Rated Voltage	Rated Current	Winding Resistance	Inductance	Motor Length
	mm/Step	Deg	Kgf	V	A	Ω	mH	mm
2H86A (Linear)	0.0127	1.8	200	3~48	5.6	0.52	2.86	76