

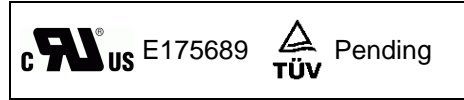

RADIAL LEADED PTC LX/LU MODEL



FEATURES

- Low hold current, Solid state
- Radial-leaded product ideal for up to 265VAC/265VDC
- Operation current: 0.05A~2.00A
- Maximum voltage: 240VAC/VDC
- Maximum interrupt voltage: 265VAC/DC
- Temperature range: -40°C to 85°C
- Cured, flame retardant epoxy polymer insulating material meets UL 94V-0 requirement
- Bulk packing, tape and reel available on most models

APPLICATIONS

- Power Supply
- Power Transformer
- 240VDC/VAC Equipment

PART NUMBERING SYSTEM

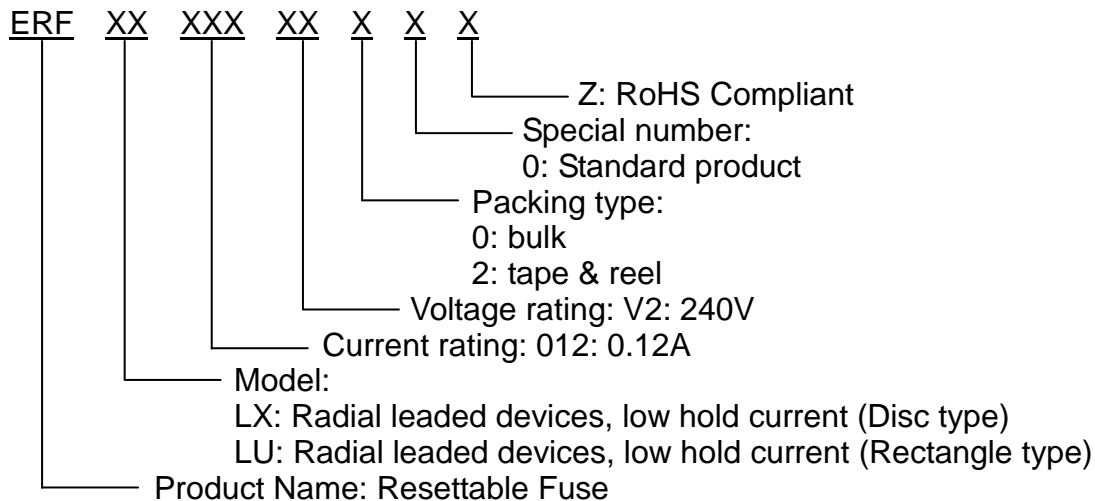

Marking system

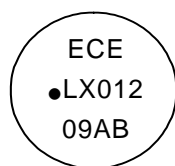

Example

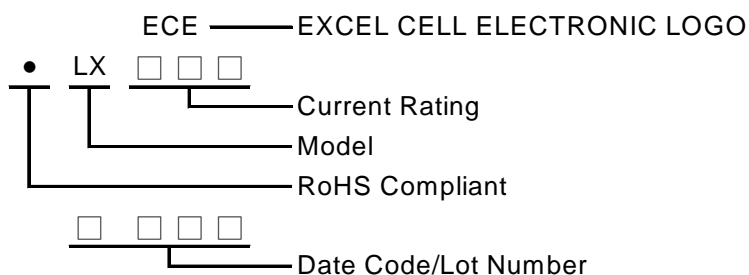



ECE —
The Name You Can Trust!

■ Electrical characteristics(23°C)

Part Number	Hold Current	Trip Current	Max. Time to trip	Maximum Current	Rated Voltage	Typical Power	Resistance Tolerance	
	I _H , A	I _T , A	at 5xI _H	I _{MAX} , A	V _{MAX} , V _{dc}	P _d , W	R _{MIN} Ω	R _{1MAX} Ω
LX005-V2	0.05	0.12	15.0	1.0	240	0.70	18.50	65.0
LX008-V2	0.08	0.19	15.0	1.2	240	0.80	7.40	26.0
LX012-V2	0.12	0.30	15.0	1.2	240	1.00	3.00	12.0
LX016-V2	0.16	0.37	15.0	2.0	240	1.40	2.50	7.80
LU025-V2	0.25	0.56	18.5	3.5	240	1.50	1.30	3.80
LU033-V2	0.33	0.74	18.5	4.5	240	1.70	0.83	2.60
LU040-V2	0.40	0.90	24.0	5.5	240	2.00	0.60	1.90
LU055-V2	0.55	1.25	26.0	7.0	240	3.40	0.45	1.45
LU075-V2	0.75	1.50	18.0	7.5	240	2.60	0.32	0.84
LX100-V2	1.00	2.00	21.0	10.0	240	2.90	0.22	0.58
LX125-V2	1.25	2.50	23.0	12.5	240	3.30	0.17	0.44
LU200-V2	2.00	4.00	28.0	20.0	240	4.50	0.09	0.22

I_H=Hold current-maximum current at which the device will not trip at 23°C still air.

I_T=Trip current-minimum current at which the device will always trip at 23°C still air.

V_{MAX}=Maximum voltage device can withstand without damage at its rated current.

I_{MAX}= Maximum fault current device can withstand without damage at rated voltage (V max).

P_d=Typical power dissipated from device when in the tripped state in 23°C still air environment.

R_{MIN}=Minimum device resistance at 23°C.

R_{1MAX}=Maximum device resistance at 23°C 1 hour after tripping .

■ Typical Time-To-Trip at 23°C

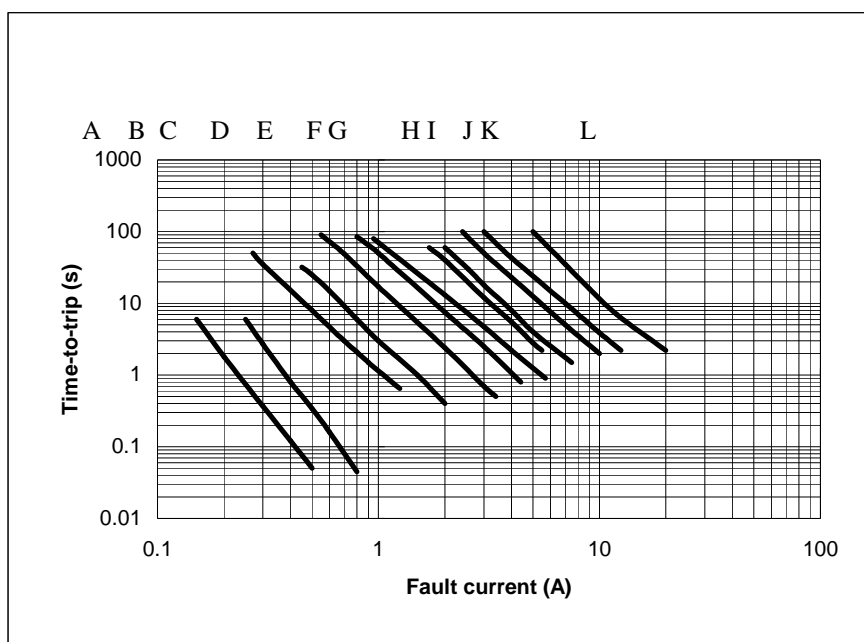

A=LX005-V2
B=LX008-V2
C=LX012-V2
D=LX016-V2
E=LU025-V2
F=LU033-V2
G=LU040-V2
H=LU055-V2
E=LU075-V2
F=LX100-V2
G=LX125-V2
H=LU200-V2

Thermal Derating Curve

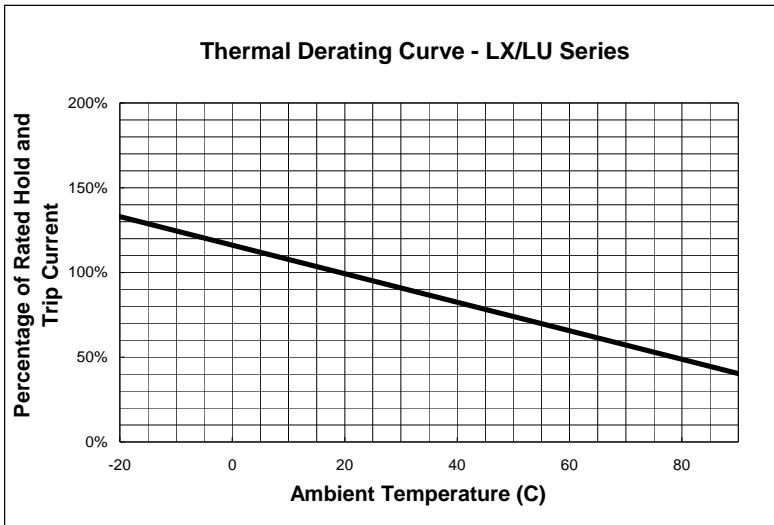

LX/LU Product Dimensions (UNIT: mm)

Part Number	A	B	C	D	E	F	Figure
	Maximum	Maximum	Typical	Minimum	Maximum	Typical	
LX005-V2	8.3	10.7	5.1	7.6	3.8	1.6	1
LX008-V2	8.3	10.7	5.1	7.6	3.8	1.6	1
LX012-V2	8.3	10.7	5.1	7.6	3.8	1.6	1
LX016-V2	9.9	12.5	5.1	7.6	3.8	1.6	1
LU025-V2	9.6	17.4	5.1	7.6	3.8	1.8	2
LU033-V2	11.4	16.5	5.1	7.6	3.8	1.8	2
LU040-V2	11.5	19.5	5.1	7.6	3.8	1.8	2
LU055-V2	14.0	21.7	5.1	7.6	4.1	1.9	3
LU075-V2	11.5	23.4	5.1	7.6	4.8	1.9	3
LX100-V2	18.7	24.4	10.2	7.6	5.1	1.9	4
LX125-V2	21.2	27.4	10.2	7.6	5.3	1.9	4
LU200-V2	24.9	33.8	10.2	7.6	6.1	1.9	3

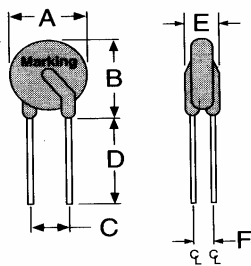

Figure 1

- Lead Size: 24AWG
- Φ 0.51mm Diameter

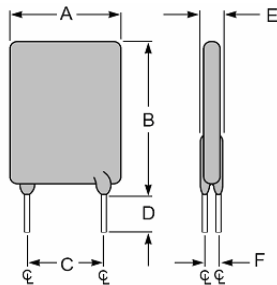

Figure 2

- Lead Size: 22AWG
- Φ 0.65mm Diameter

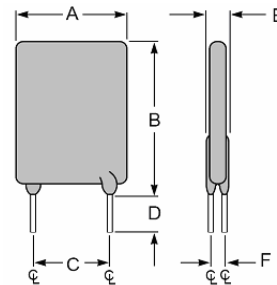

Figure 3

- Lead Size: 20AWG
- Φ 0.81mm Diameter

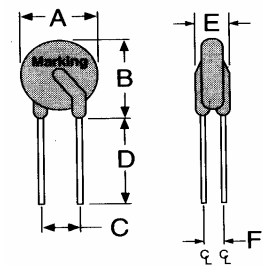
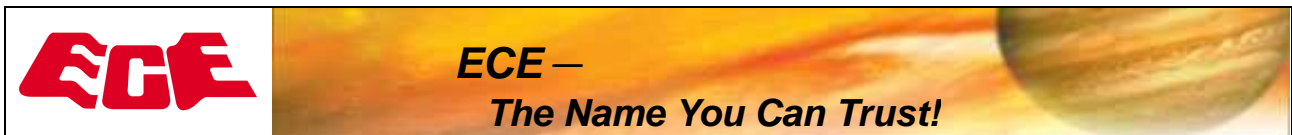

Figure 4

- Lead Size: 20AWG
- Φ 0.81mm Diameter



■ Standard Package for Reference

P/N	Pcs/Bag	Reel/Tape	P/N	Pcs/Bag	Reel/Tape
LX005-V2	500	2.0K	LU040-V2	200	2.0K
LX008-V2	500	2.0K	LU055-V2	200	1.0K
LX012-V2	500	2.0K	LU075-V2	200	2.0K
LX016-V2	500	2.0K	LX100-V2	100	----
LU025-V2	300	2.0K	LX125-V2	100	----
LU033-V2	200	2.0K	LU200-V2	100	----