

**RADIAL LEADED PTC
EX/EU MODEL**

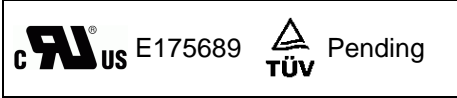

FEATURES

- Solid state, Radial leaded product ideal for up to 120VAC/VDC
- Operation current: 0.10A~3.75A
- Maximum Voltage: 120VAC/VDC
- Maximum Interrupt Voltage: 135VAC/VDC
- Temperature range: -40°C to 85°C
- Cured, flame retardant epoxy polymer insulating material meets UL 94V-0 requirement
- Bulk packing, tape and reel available on most models

APPLICATIONS

- Line voltage power supply
- Transformer and appliances product

PART NUMBERING SYSTEM

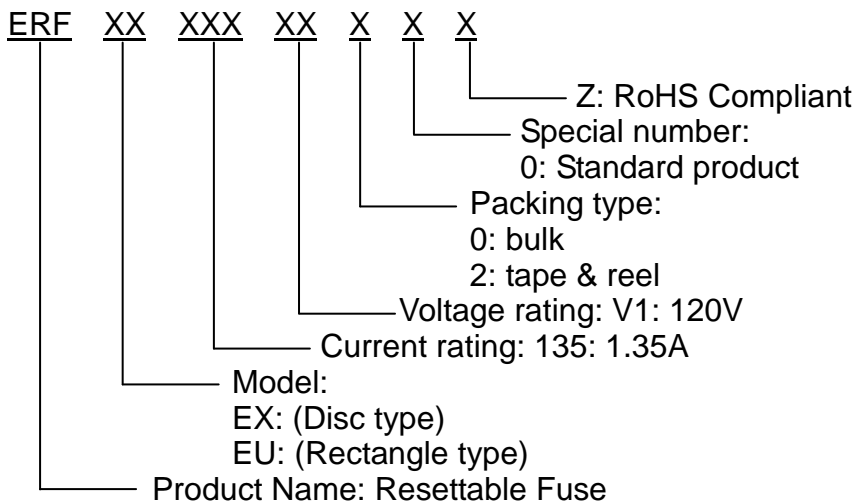

Marking system

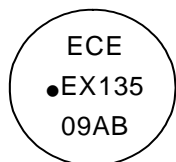

Example

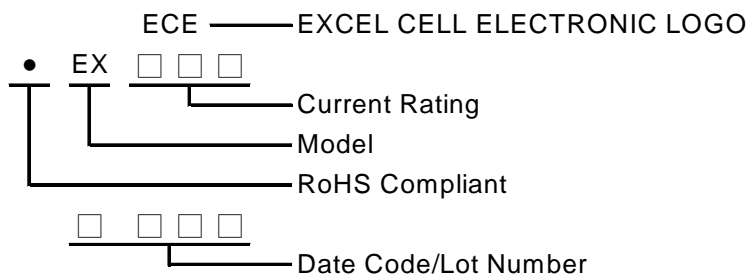

*If the current rating is under 1Amp their will be no " ECE " logo shown on the body.



ECE —
The Name You Can Trust!

■ Electrical characteristics(23°C)

Part Number	Hold Current	Trip Current	Max. Time to trip	Max. Current	Max. Oper. Voltage	Max. Int. Voltage	Typical Power	Resistance Tolerance	
	I _H , A	I _T , A	at 5x I _H	I _{MAX} , A	V _{MAX} , V _{AC/DC}	V _{I-MAX} , V _{AC/DC}		R _{MIN}	R _{1MAX}
							P _d , W	Ω	Ω
EX010-V1	0.10	0.20	10.0	2.0	120	135	0.84	3.00	7.50
EX017-V1	0.17	0.34	10.0	2.0	120	135	0.84	2.00	7.00
EX020-V1	0.20	0.40	9.0	2.0	120	135	1.08	1.83	4.40
EX025-V1	0.25	0.50	7.5	3.0	120	135	1.08	1.25	3.00
EX030-V1	0.30	0.60	8.5	3.0	120	135	1.44	0.88	2.10
EX040-V1	0.40	0.80	6.5	3.0	120	135	1.44	0.55	1.29
EX050-V1	0.50	1.00	6.0	3.0	120	135	1.56	0.50	1.17
EX065-V1	0.65	1.30	5.7	5.0	120	135	1.68	0.31	0.72
EX075-V1	0.75	1.50	6.3	5.0	120	135	1.80	0.25	0.60
EX090-V1	0.90	1.80	7.2	5.0	120	135	1.80	0.20	0.47
EX110-V1	1.10	2.20	8.2	8.0	120	135	2.28	0.15	0.38
EX135-V1	1.35	2.70	9.6	10.0	120	135	2.64	0.12	0.30
EX160-V1	1.60	3.20	11.4	12.0	120	135	3.12	0.09	0.22
EX185-V1	1.85	3.70	12.6	12.0	120	135	3.36	0.08	0.19
EX250-V1	2.50	5.00	15.6	15.0	120	135	4.44	0.05	0.13
EX300-V1	3.00	6.00	19.8	17.0	120	135	4.56	0.04	0.10
EX375-V1	3.75	7.50	24.0	20.0	120	135	4.80	0.03	0.08
EU075-V1	0.75	1.50	15.0	7.5	120	135	2.64	0.25	0.69
EU100-V1	1.00	2.00	15.0	10.0	120	135	2.64	0.18	0.47
EU125-V1	1.25	2.50	20.0	12.5	120	135	2.88	0.11	0.33
EU135-V1	1.35	2.70	20.0	13.5	120	135	3.12	0.11	0.30
EU200-V1	2.00	4.20	36.0	20.0	120	135	4.32	0.08	0.21

I_H=Hold current-maximum current at which the device will not trip at 23°C still air.

I_T=Trip current-minimum current at which the device will always trip at 23°C still air.

V_{MAX}=Maximum voltage device can withstand without damage at its rated current.

I_{MAX}= Maximum fault current device can withstand without damage at rated voltage (V max).

P_d=Typical power dissipated from device when in the tripped state in 23°C still air environment.

R_{MIN}=Minimum device resistance at 23°C.

R_{1MAX}=Maximum device resistance at 23°C 1 hour after tripping .



ECE —
The Name You Can Trust!

■ Typical Time-To-Trip at 23°C

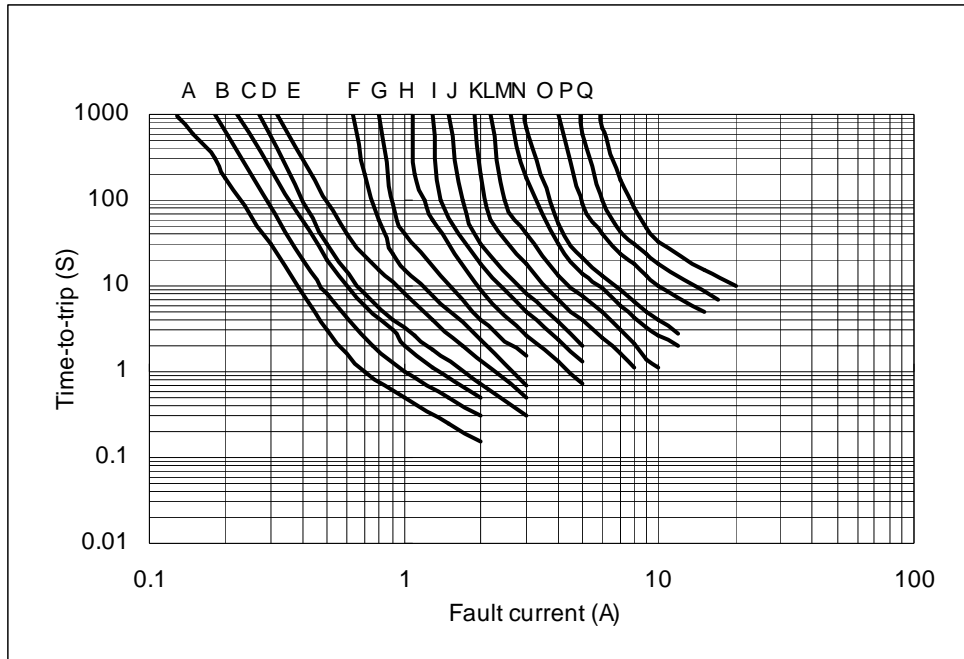

A=EX010-V1
B=EX017-V1
C=EX020-V1
D=EX025-V1
E=EX030-V1
F=EX040-V1
G=EX050-V1
H=EX065-V1
I=EX075-V1
J=EX090-V1
K=EX110-V1
L=EX135-V1
M=EX160-V1
N=EX185-V1
O=EX250-V1
P=EX300-V1
Q=EX375-V1

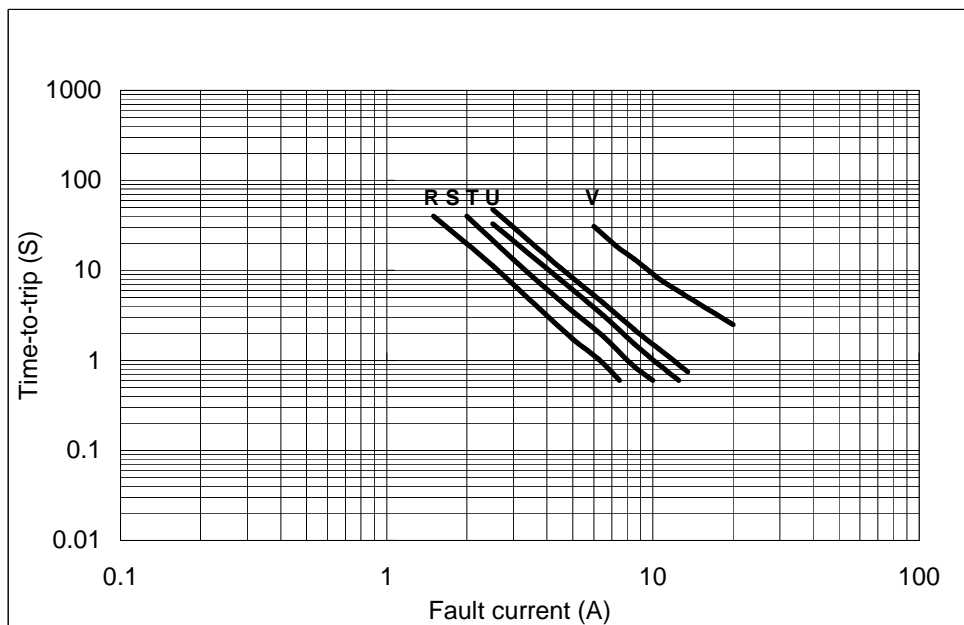

R=EU075-V1
S=EU100-V1
T=EU125-V1
U=EU135-V1
V=EU200-V1



ECE —
The Name You Can Trust!

■ Thermal Derating Curve

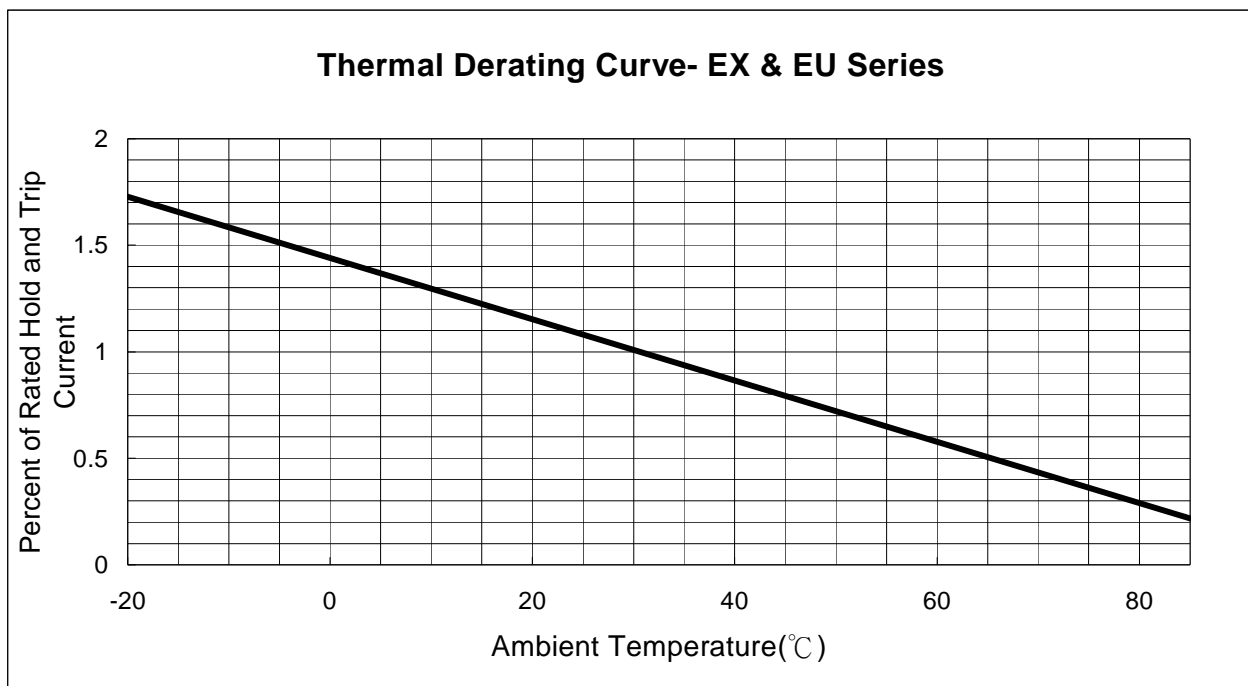

■ Standard Package for Reference

P/N	Pcs/Bag	Reel/Tape	P/N	Pcs/Bag	Reel/Tape
EX010-V1	500	2.0K	EX135-V1	200	1.0K
EX017-V1	500	2.0K	EX160-V1	200	-----
EX020-V1	500	2.0K	EX185-V1	100	-----
EX025-V1	500	2.0K	EX250-V1	100	-----
EX030-V1	500	2.0K	EX300-V1	100	-----
EX040-V1	500	2.0K	EX375-V1	100	-----
EX050-V1	500	2.0K	EU075-V1	300	1.5K
EX065-V1	300	1.5K	EU100-V1	300	1.5K
EX075-V1	300	1.5K	EU125-V1	200	1.0K
EX090-V1	300	1.5K	EU135-V1	200	1.0K
EX110-V1	300	1.5K	EU200-V1	100	-----

■ EX/EU Product Dimensions (UNIT: mm)

Part Number	A	B	C	D	E	F	Figure
	Maximum	Maximum	Typical	Minimum	Maximum	Typical	
EX010-V1	7.9	13.0	5.1	7.6	3.8	2.2	1
EX017-V1	7.9	13.0	5.1	7.6	3.8	2.2	1
EX020-V1	7.9	13.0	5.1	7.6	3.8	2.2	2
EX025-V1	7.9	13.0	5.1	7.6	3.8	2.2	2
EX030-V1	7.9	13.0	5.1	7.6	3.8	2.2	2
EX040-V1	8.2	14.2	5.1	7.6	3.8	2.2	2
EX050-V1	9.2	14.9	5.1	7.6	3.8	2.2	2
EX065-V1	9.7	14.9	5.1	7.6	3.8	2.2	2
EX075-V1	10.6	15.5	5.1	7.6	3.8	2.2	2
EX090-V1	11.9	15.9	5.1	7.6	3.8	2.2	2
EX110-V1	13.3	18.3	5.1	7.6	4.1	2.2	3
EX135-V1	15.5	20.6	5.1	7.6	4.1	2.2	3
EX160-V1	17.5	22.5	5.1	7.6	4.1	2.2	3
EX185-V1	19.9	24.9	5.1	7.6	4.1	2.2	3
EX250-V1	22.5	27.5	10.2	7.6	4.1	2.2	3
EX300-V1	25.5	30.0	10.2	7.6	4.1	2.2	3
EX375-V1	29.5	34.0	10.2	7.6	4.1	2.2	3
EU075-V1	10.9	17.0	5.1	7.6	4.1	2.2	4
EU100-V1	11.5	20.1	5.1	7.6	4.1	2.2	4
EU125-V1	14.0	21.7	5.1	7.6	4.1	2.2	4
EU135-V1	16.3	21.7	5.1	7.6	4.1	2.2	4
EU200-V1	23.5	27.9	10.2	7.6	4.1	2.2	4

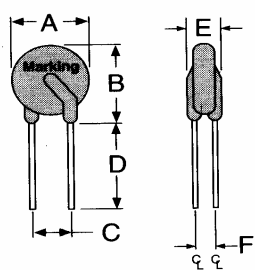

Figure 1

- Lead Size: 24AWG
- Φ0.51mm Diameter

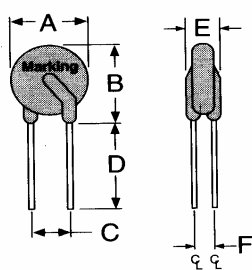

Figure 2

- Lead Size: 22AWG
- Φ 0.65mm Diameter

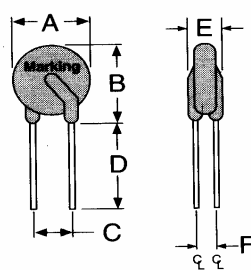

Figure 3

- Lead Size: 20AWG
- Φ0.81mm Diameter

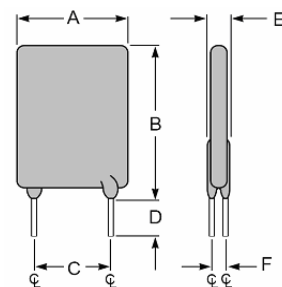

Figure 4

- Lead Size: 20AWG
- Φ0.81mm Diameter