

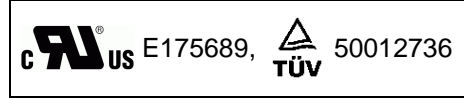

RADIAL LEADED PTC RG MODEL



■ FEATURES

- Very high hold current, Solid state
- Radial-leaded product ideal for up to 16Vdc
- Operation current: 2.5A~14A
- Maximum voltage: 16V
- Temperature range -40°C to 85°C
- Cured, flame retardant epoxy polymer insulating material meets UL 94V-0 requirement
- Bulk packing, tape and reel available on most models

■ APPLICATIONS

- Audio Equipment
- Automotives Electronic
- Fire Alarm / Security System
- Halogen Light
- Medical / Test Equipment
- Wire Harness

■ PART NUMBERING SYSTEM

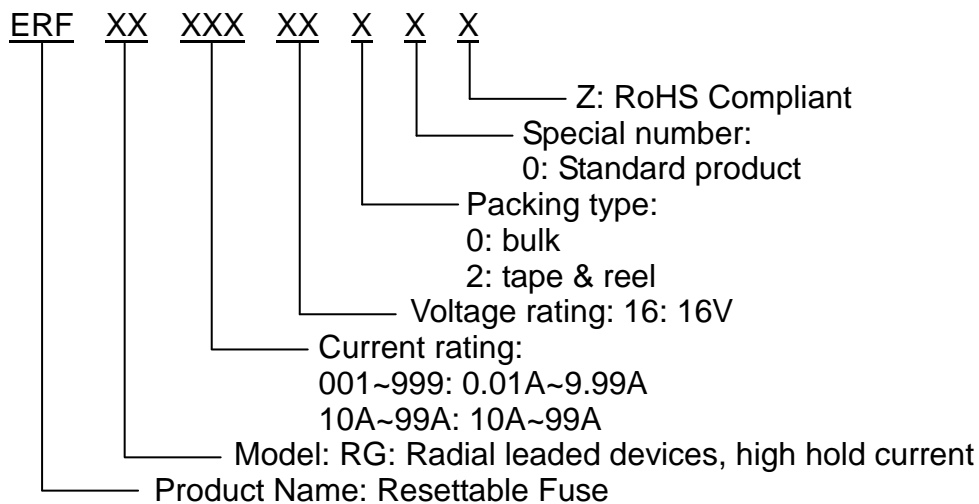



ECE —
The Name You Can Trust!

■ Marking system

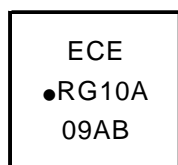

Example

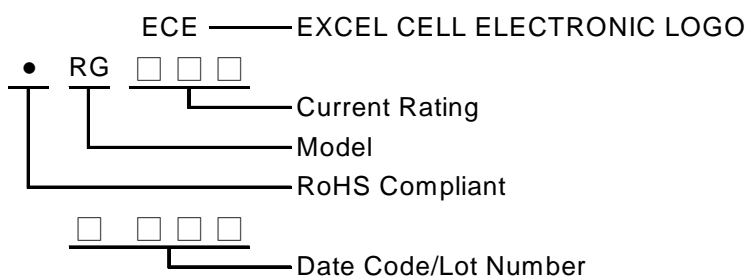

■ Electrical characteristics(23°C)

Part Number	Hold Current	Trip Current	Max. Time to trip	Maximum Current	Rated Voltage	Typical Power	Resistance Tolerance	
							R _{MIN}	R _{1MAX}
	I _H , A	I _T , A	at 5xI _H	I _{MAX} , A	V _{MAX} , V _{dc}	P _d , W	Ω	Ω
RG250-16	2.5	4.7	5.0	100	16	1.0	0.022	0.053
RG300-16	3.0	5.1	2.0	100	16	2.3	0.034	0.105
RG400-16	4.0	6.8	3.5	100	16	2.4	0.020	0.063
RG500-16	5.0	8.5	3.6	100	16	2.6	0.010	0.044
RG600-16	6.0	10.2	5.8	100	16	2.8	0.009	0.033
RG700-16	7.0	11.9	8.0	100	16	3.0	0.006	0.021
RG800-16	8.0	13.6	9.0	100	16	3.0	0.005	0.018
RG900-16	9.0	15.3	12.0	100	16	3.3	0.004	0.015
RG10A-16	10.0	17.0	12.5	100	16	3.3	0.003	0.012
RG11A-16	11.0	18.7	13.5	100	16	3.7	0.003	0.010
RG12A-16	12.0	20.4	16.0	100	16	4.2	0.002	0.009
RG14A-16	14.0	23.8	20.0	100	16	4.6	0.002	0.008

I_H=Hold current-maximum current at which the device will not trip at 23°C still air.

I_T=Trip current-minimum current at which the device will always trip at 23°C still air.

V_{MAX}=Maximum voltage device can withstand without damage at its rated current.

I_{MAX}= Maximum fault current device can withstand without damage at rated voltage (V max).

P_d=Typical power dissipated from device when in the tripped state in 23°C still air environment.

R_{MIN}=Minimum device resistance at 23°C .

R_{1MAX}=Maximum device resistance at 23°C 1 hour after tripping .



ECE —
The Name You Can Trust!

■ Typical Time-To-Trip at 23°C

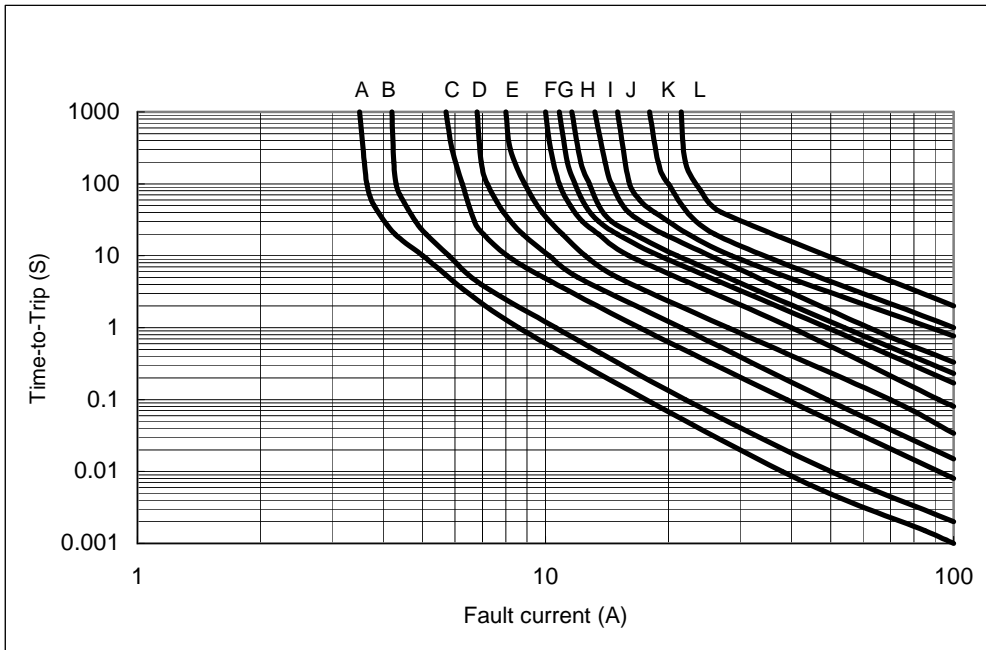

A=RG250-16
B=RG300-16
C=RG400-16
D=RG500-16
E=RG600-16
F=RG700-16
G=RG800-16
H=RG900-16
I=RG10A-16
J=RG11A-16
K=RG12A-16
L=RG14A-16

■ Thermal Derating Curve

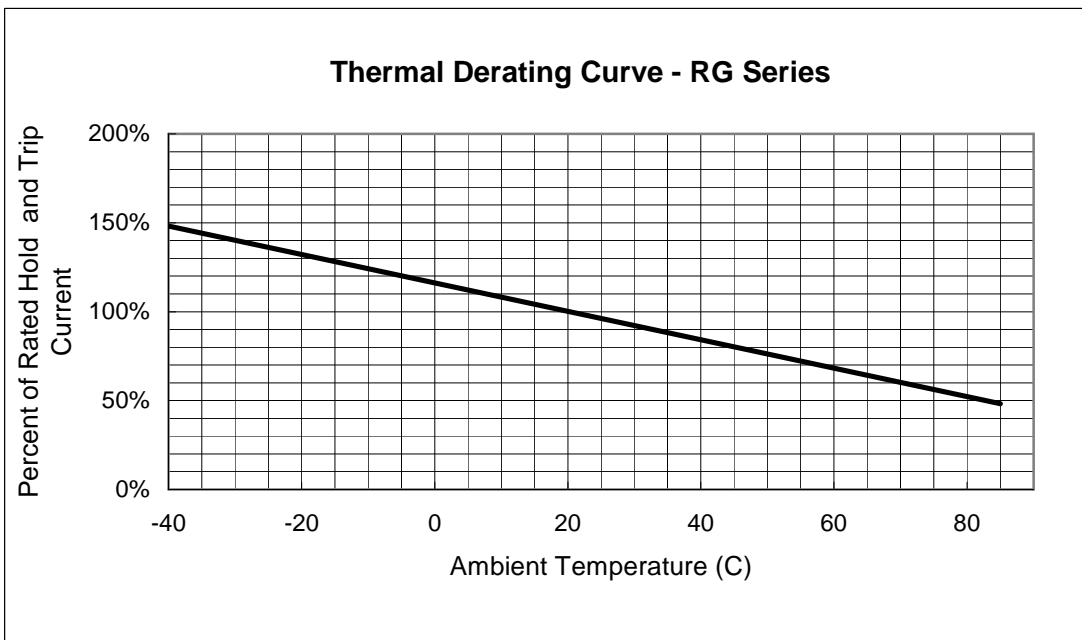

■ **RG Product Dimensions (UNIT: mm)**

Part Number	A	B	C	D	E	F
	Maximum	Maximum	Typical	Minimum	Maximum	Typical
RG250-16	8.9	12.8	5.1	7.6	3.0	1.2
RG300-16	7.1	11.0	5.1	7.6	3.0	1.2
RG400-16	8.9	12.8	5.1	7.6	3.0	1.2
RG500-16	10.4	14.3	5.1	7.6	3.0	1.2
RG600-16	10.7	17.1	5.1	7.6	3.0	1.2
RG700-16	11.2	19.7	5.1	7.6	3.0	1.2
RG800-16	12.7	20.9	5.1	7.6	3.0	1.2
RG900-16	14.0	21.7	5.1	7.6	3.0	1.2
RG10A-16	16.5	24.1	5.1	7.6	3.0	1.2
RG11A-16	17.5	26.0	5.1	7.6	3.0	1.2
RG12A-16	17.5	28.0	10.2	7.6	3.6	1.4
RG14A-16	27.9	27.9	10.2	7.6	3.6	1.4

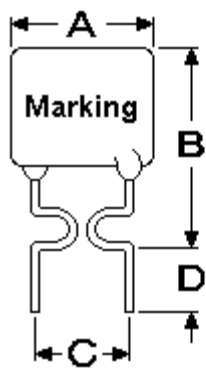

RG 250-16

- Lead Size: 24AWG
- φ0.51mm Diameter

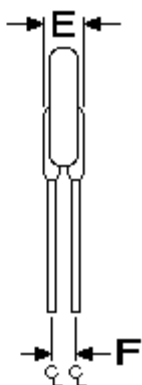

RG 300-16 ~ RG 11A-16

- Lead Size: 20AWG
- φ0.81mm Diameter

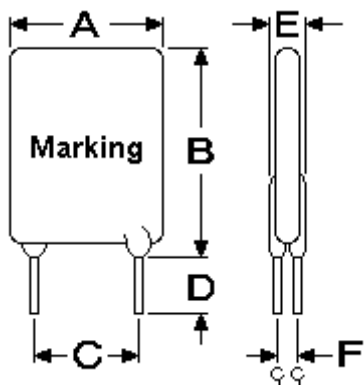

RG 12A-16 ~ RG 14A-16

- Lead Size: 18AWG
- φ1.0mm Diameter

■ **Standard Package for Reference**

P/N	Pcs/Bag	Reel/Tape	P/N	Pcs/Bag	Reel/Tape
RG250-16	500	2.5K	RG800-16	200	-----
RG300-16	500	2.5K	RG900-16	200	-----
RG400-16	300	2.5K	RG10A-16	100	-----
RG500-16	300	2.5K	RG11A-16	100	-----
RG600-16	300	2.5K	RG12A-16	100	-----
RG700-16	200	1.5K	RG14A-16	100	-----