

EUROSTYLE P.C.B. TERMINAL BLOCK

TÜV R50002918
E133988(R)

ETB22 SERIES

CLAMPING TYPE

PITCH=5.0 / 10.0mm

FEATURES

- Easy to assemble for any number of positions
- End stackable without any loss of P.C.B. space
- Special wire protector design to ensure reliable wire clamping
- UL 94V-0 grade fire retardant engineering plastic used for the housing
- Be capable of clamping a wide range of wire diameters
- Compact size for P.C.B.

SPECIFICATIONS

- Pitch 5.0mm, 10.0mm
- Wire range 24~14 AWG (2.5mm²)
- No. of pole per block 2P or 3P
- Rating 10 Amp, 300 VAC
- Housing PA66
- Terminals Tin plated over Brass
- Screws M2.5x0.45P, Zinc plated over Steel
- Wire cage Nickel plated over Zinc Alloy
- Torque 0.4 N-m (3.5 lb-in) (tested by manual torque screwdriver)
- Operating temperature -30°C ~+105°C (includes temperature rise limit)
- Stripping length 6mm
- UL Approval 300V, 10A, 24~14 AWG
- TUV Approval 250V, T100, 1.5mm²



PART NUMBERING SYSTEM

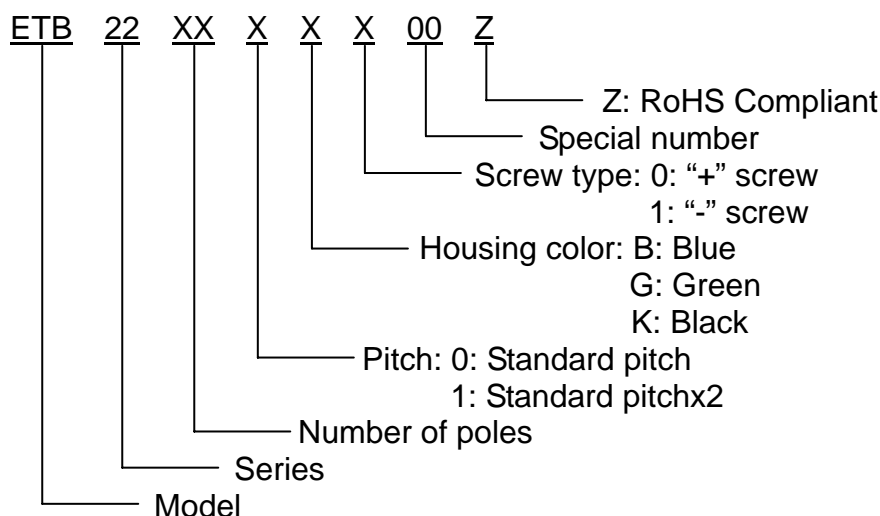

DRAWING

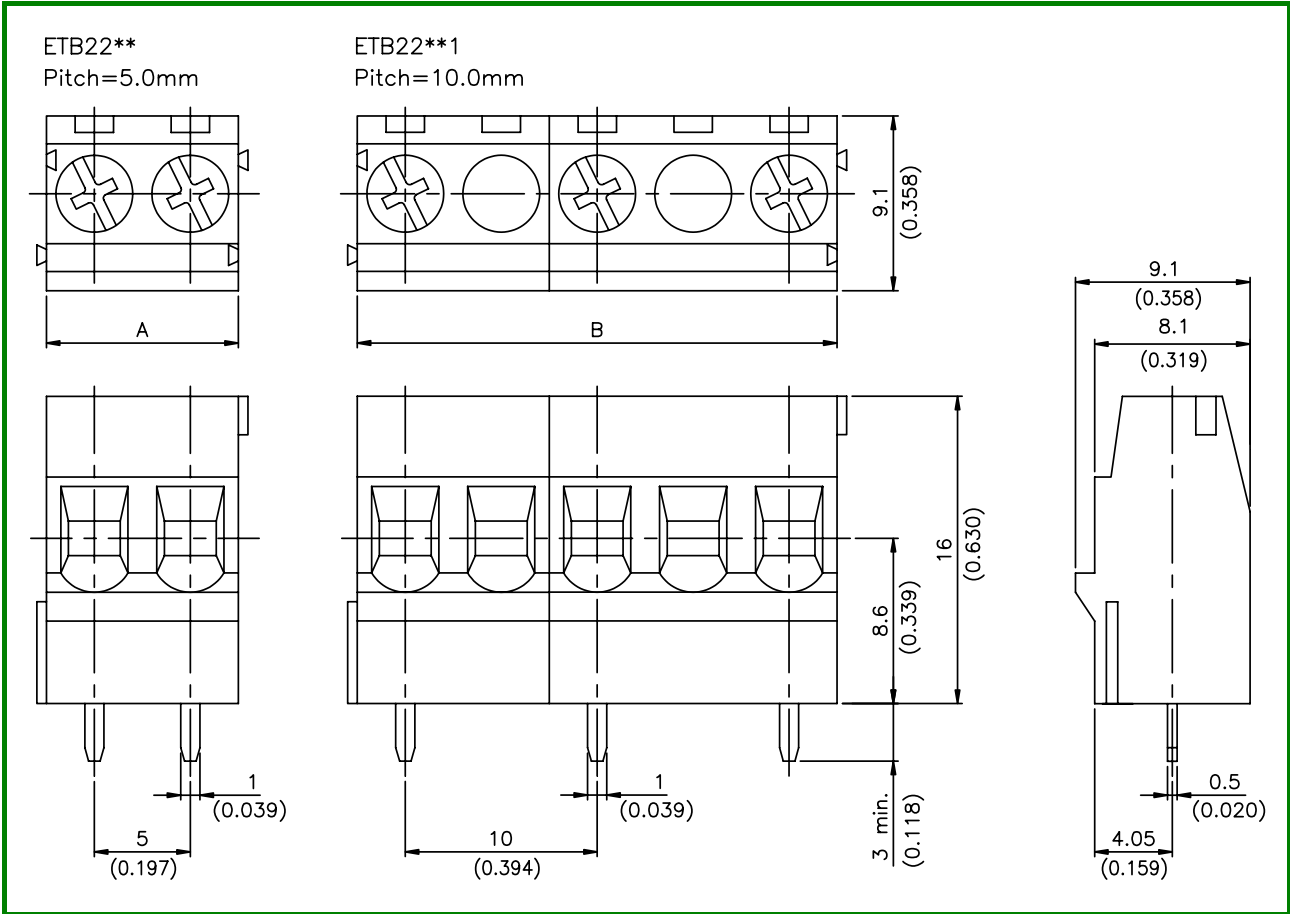

POLE DIM.	2	3	4	5	6	7	8	9	10	11	12	13
A	10 (0.394)	15 (0.591)	20 (0.787)	25 (0.984)	30 (1.181)	35 (1.378)	40 (1.575)	45 (1.772)	50 (1.969)	55 (2.165)	60 (2.362)	65 (2.559)
B	15 (0.591)	25 (0.984)	35 (1.378)	45 (1.772)	55 (2.165)	65 (2.559)	75 (2.953)	85 (3.346)	95 (3.740)	105 (4.134)	115 (4.528)	
POLE DIM.	14	15	16	17	18	19	20	21	22	23	24	
A	70 (2.756)	75 (2.953)	80 (3.150)	85 (3.346)	90 (3.543)	95 (3.740)	100 (3.937)	105 (4.134)	110 (4.331)	115 (4.528)	120 (4.724)	