

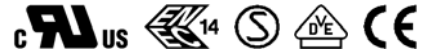

**MICRO SWITCH  
EV SERIES**



**FEATURES**

- High applicability for general industrial equipment and home appliances
- High precision mechanism design offering durable acute operation and long life
- Heavy/Light operation force specifications
- Three Kinds of terminal available #187 quick connect/solder, #187 quick connect and #250 quick connect type
- RoHS Compliant

**APPLICATIONS**

- Home appliances
- Vending machines
- Amusement and communication equipment
- Office automation appliances
- General industrial machines

**SPECIFICATIONS**

**1. ELECTRICAL**

TYPE		EV-11	EV-16	EV-21
DESCRIPTION				
Contact Rating:	AC 125V	11A 1/2HP	16A 1/2HP	21A 1/2HP
	AC 250V	11A 1/2HP	16A 1/2HP	21A 1/2HP
	DC 125V	0.6A	0.6A	0.6A
	DC 250V	0.3A	0.3A	0.3A
Contact Resistance: (Initial)		50mΩ Max.		
Insulation Resistance		100 MΩ Min. at 500 VDC		





## 2. CHARACTERISTICS

TYPE		EV-11	EV-16	EV-21
DESCRIPTION				
Mechanical Life (Cycles Operations)		50,000,000		
Electrical Life (Cycles Operations)		300,000	100,000	100,000
Ambient Temperature		-25°C to +80°C (without dew condensation)		
Ambient Humidity		Max. 85% RH		
Max. operating cycle rate	Mechanical	600 cycle/min.		
	Electrical	60 cycle/min.		
Allowable Operation speed		0.1 to 1,000 mm/sec (without lever)		
Dielectric Strength	Between non-continuous terminal	AC 1000Vrms		
	Between each terminal and other exposed metal parts	AC 2000Vrms		
	Between each terminal and ground	AC 2000Vrms		
Vibration Resistance (Without lever)		10 to 55 Hz amplitude of 1.5mm		
Shock Resistance (Without lever)		200m/s <sup>2</sup> {20G}Min.	300m/s <sup>2</sup> {30G}Min.	300m/s <sup>2</sup> {30G}Min.
Unit weight		Approx 6.5g		

## ■ PART NUMBERING SYSTEM

EV - XX X X X X XX

XX: Special product number

Operation force: (Without lever)

- 1: 100 gf (EV11)
- 2: 200 gf (EV11, EV16)
- 3: 400 gf (EV11, EV16, EV21)

Actuator type:

- 0: Without lever
- 1: Short straight lever
- 2: Straight lever
- 3: Long straight lever
- 4: Simulated roller lever
- 5: Short roller lever
- 6: Roller lever

Terminal type:

- 1: #187 Quick connect/solder terminal (EV11, EV16)
- 2: #187 Quick connect terminal (EV11)
- 3: #250 Quick connect terminal (EV11, EV16, EV21)

Contact arrangement:

- 1: Bottom COM, SPST-NO (1a)
- 2: Bottom COM, SPST-NC (1b)
- 3: Bottom COM, SPDT (1c)
- 4: Side COM, SPST-NO (1a)
- 5: Side COM, SPST-NC (1b)
- 6: Side COM, SPDT (1c)







Rating current:

- 11: 11 Ampere
- 16: 16 Ampere
- 21: 21 Ampere



Series name:

EV: V type micro switch

### Actuators

0	Without lever	
1	Short straight lever	
2	Straight lever	
3	Long straight lever	
4	Simulated roller lever	
5	Short roller lever	
6	Roller lever	

### Terminal type

1	#187 Quick connect/solder terminal	
2	#187 Quick connect terminal	
3	#250 Quick connect terminal	

## CIRCUIT DIMENSIONS

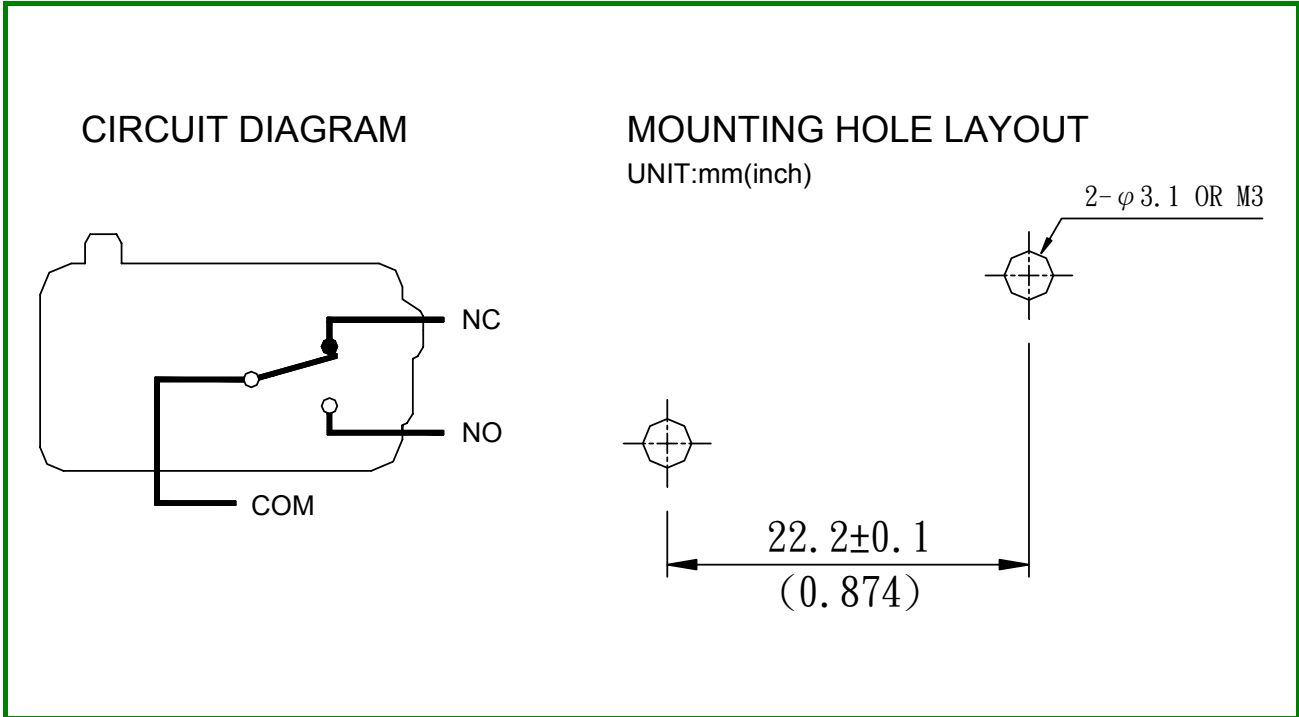

## DIMENSIONS UNIT:mm(inch)

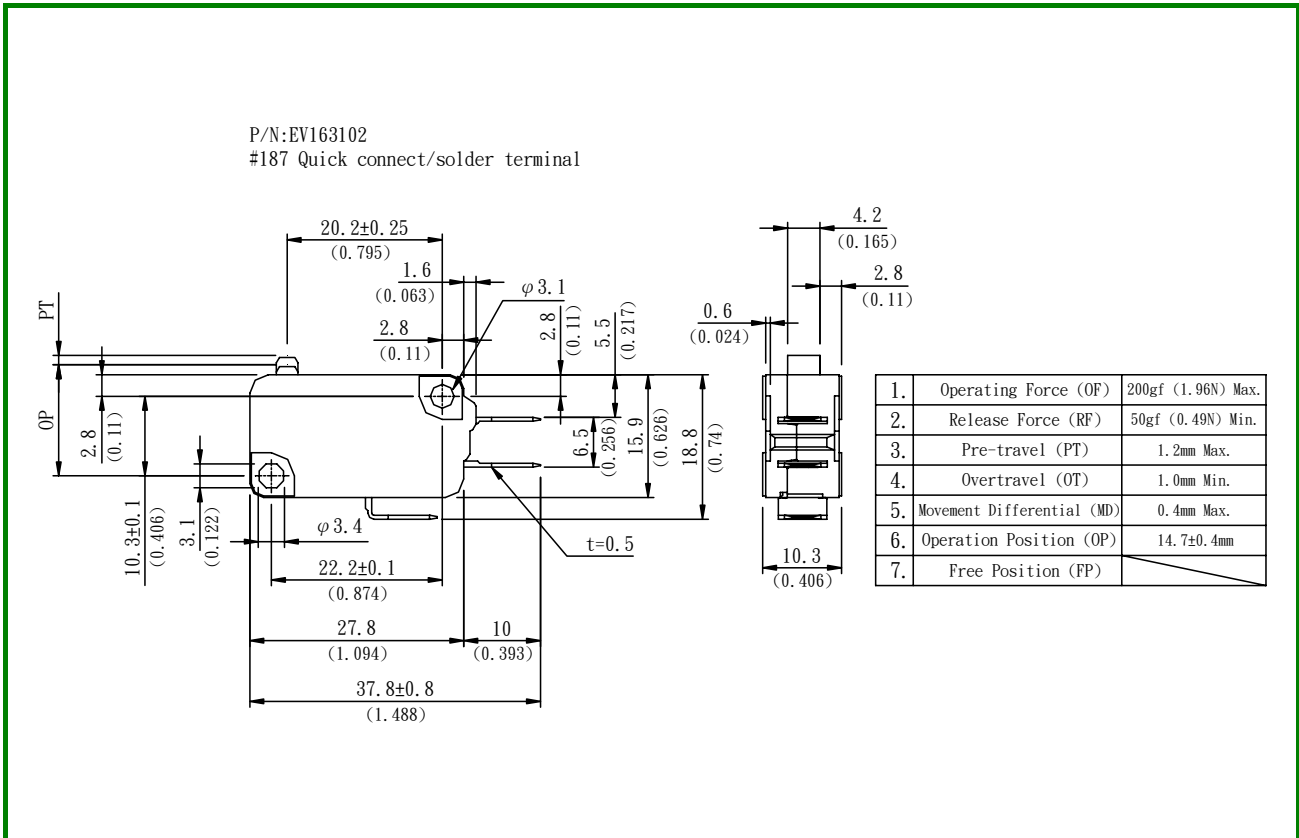

P/N:EV163112  
 #187 Quick connect/solder terminal  
 Short Straight lever

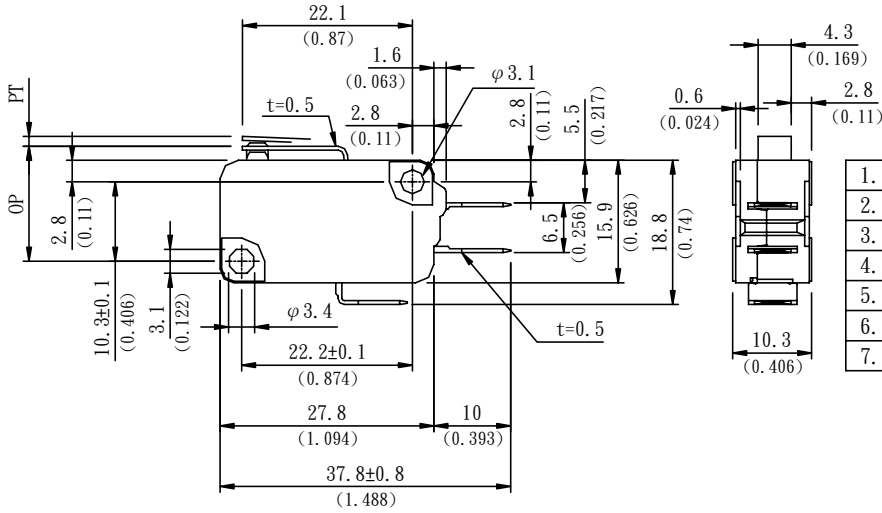

1.	Operating Force (OF)	200gf (1.96N) Max.
2.	Release Force (RF)	50gf (0.49N) Min.
3.	Pre-travel (PT)	1.6mm Max.
4.	Overtravel (OT)	0.8mm Min.
5.	Movement Differential (MD)	0.6mm Max.
6.	Operation Position (OP)	15.2±0.5mm
7.	Free Position (FP)	

P/N:EV163122  
 #187 Quick connect/solder terminal  
 Straight lever

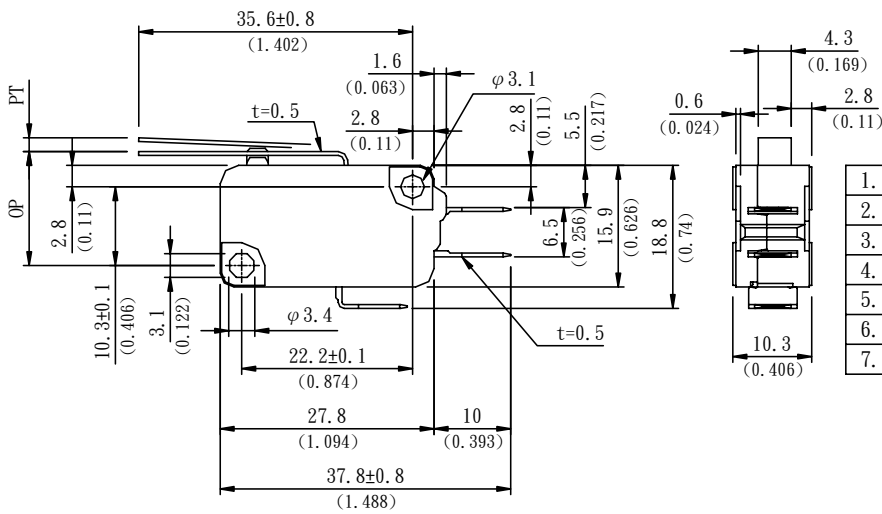

1.	Operating Force (OF)	125gf (1.23N) Max.
2.	Release Force (RF)	14gf (0.14N) Min.
3.	Pre-travel (PT)	4.0mm Max.
4.	Overtravel (OT)	1.6mm Min.
5.	Movement Differential (MD)	1.5mm Max.
6.	Operation Position (OP)	15.2±1.2mm
7.	Free Position (FP)	



P/N: EV163152  
 #187 Quick connect/solder terminal  
 Short roller lever

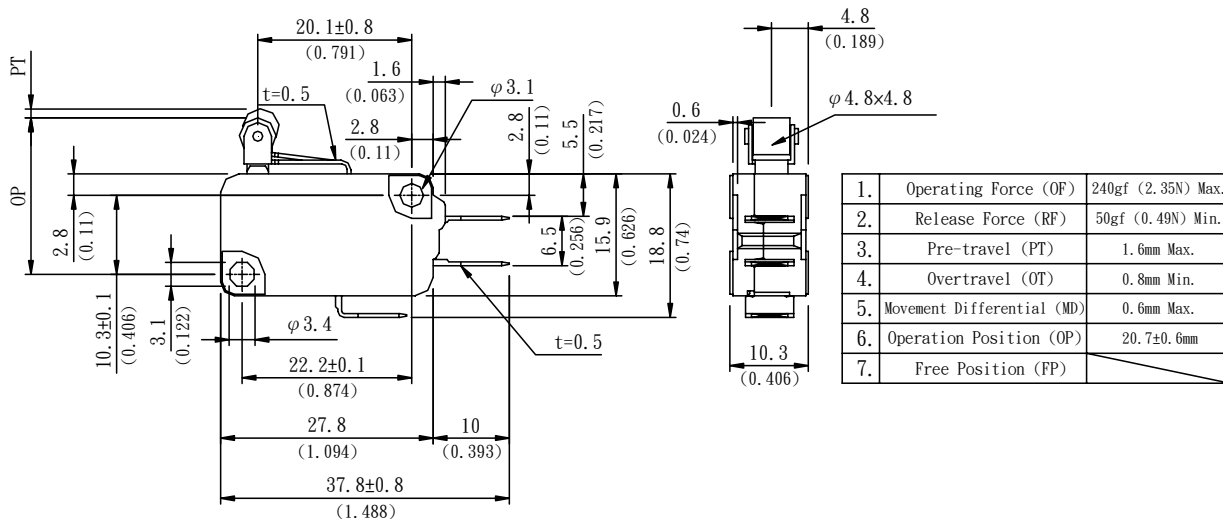

P/N: EV163162  
 #187 Quick connect/solder terminal  
 Long roller lever

